

# Mamiya RB67

PROFESSIONAL

[www.ianbfoto.com](http://www.ianbfoto.com)

## INSTRUCTIONS



**Congratulations on your purchase of a Mamiya RB67 camera.**

Reading this manual carefully beforehand will ensure correct camera operation and eliminate any possibility of malfunction.

The Mamiya RB67 camera is part of a unique camera system, developed by the Mamiya Camera Company, the recognized world leader in large format photography. It takes its place alongside the famous Mamiya C Professional and the Mamiya Press cameras.

The versatility of the Mamiya RB67, embodying fine performance and various capabilities, results in a large format camera that meets and satisfies all the requirements of the advanced amateur as well as the professional photographer. Its interlocking use of many Mamiya Press camera accessories further widens its range of photographic application.



## ■ Special Pointers in Using the Mamiya RB 67



Under any of the following conditions the camera's safety interlock mechanism will engage. This may seem to be a camera malfunction. A few of these conditions are listed below. The page in the instruction manual covering these situations is indicated in parenthesis.

### Condition: Shutter release button will not release.

1. **When the mirror is up:**  
Press the shutter cocking lever (pg. 12).
2. **When the dark slide is not pulled out:**  
Pull out the dark slide (pg. 18).
3. **When the shutter release button is locked:**  
Turn the shutter release lock ring counterclockwise (pg. 12).
4. **When the revolving adapter is not turned fully to the click stop position:**  
Turn the revolving adapter a full 90° until it clicks and stops (pg. 14).
5. **When the slide lock is stopped halfway:**  
Move the slide lock to its stopping position (pg. 12).

### Condition: Lens cannot be removed.

1. Press the shutter cocking lever down fully, and then turn the bayonet ring counterclockwise. (pg. 11)

### Condition: Roll film holder cannot be removed.

1. Insert the dark slide completely, then move the slide locks (pg. 18).

## CONTENTS

### Precautions :

**Press the shutter cocking lever down fully until it stops. Never release it halfway.**

When the shutter cocking lever is released halfway and it returns, the warning signal on the roll film holder turns red even when the shutter is not released (pg. 22).

**When the mirror release operating knob on the lens is set to "M" photographs cannot be taken merely by pressing the shutter button.**

Normally it is set to the "N" position (pg. 30).



2

Special pointers in using the Mamiya RB 67.....	1
Specifications of the Mamiya RB 67 .....	3
Features of Mamiya RB 67 .....	4
Names of parts for operation .....	6
Rear body cap.....	9
Attaching and removing lenses.....	10
Shutter operation .....	12
How to handle the focusing hood .....	13
Focusing screen .....	14
Revolving adapter .....	14
How to use the lens hood .....	16
Carrying strap .....	16
Attaching and detaching the roll film holder .....	17
Roll film holder safety devices .....	18
Handling the roll film holder .....	19
Loading film .....	20
Photographing.....	22
120 Roll film holder 6 x 4.5.....	23
Distance scale .....	24
Close-up photography.....	24
Using a tripod .....	25
Close-up photography with the auto extension tubes .....	26
How to read depth of field .....	28
Flash photography .....	29
Mirror-up photography.....	30
Mamiya RB67 operation diagram .....	31
Lens (with Seiko #1 shutter).....	32
Accessories .....	39
Lock system of the camera back .....	44
Adapter for using Mamiya accessories .....	45
General accessories.....	46
System chart .....	48

## ■ Specifications of Mamiya RB 67

### Camera body (with revolving adapter)

Type: 6x7 cm lens-shutter type, single-lens reflex camera  
Lens mount: Bayonet with safety lock ring  
Focusing hood: Interchangeable  
Focusing screen: Interchangeable  
Interchangeable camera back: R-lock system  
Revolving adapter (Remove able): G-lock system  
Revolves up to 90°  
Bellows extension: Maximum 46 mm

### Lens

Mamiya Sekor 90 mm f/3.8 with lens hood  
Mamiya Sekor 127 mm f/3.8 with lens hood  
Aperture scale (f-stops): 3.8, 5.6, 8, 11, 16, 22 and 32  
(with click-stop for half step aperture settings, and with depth of field preview lever.)  
Shutter: Seiko #1 shutter  
Shutter speed scale (seconds): T, 1, 1/2, 1/4, 1/8, 1/15, 1/30, 1/60, 1/125, 1/250, 1/400  
Flash synchronization: M-X  
Independent mirror release  
Filter diameter: 77 mm

### Roll film holder

#### 120 roll film holder

10 exposures in 6x7 cm (2-1/4"x2-3/4") format  
Film used: 120 roll film  
Film advance: One-stroke lever film advance  
(Can be wound in several short, definite strokes)  
Film counter: Automatic resetting  
Double-exposure warning device

#### 220 roll film holder

20 exposures in 6x7 cm (2-1/4"x2-3/4") format  
Film used: 220 roll film  
Other specifications are the same as 120 roll film holder.

### Dimensions : (Camera body with roll film holder)

Height: 5-1/2 in. (139 mm)  
Width: 4-3/32 in. (104 mm)  
Length: 8-29/32 in. (226 mm) (with 90 mm f/3.8 lens)  
8-17/32 in. (217 mm) (with 127 mm f/3.8 lens)  
Weight: Camera body with revolving adapter and focusing hood..... 3 lbs, 4-1/4 oz (1480 g)  
Roll film holder ..... 4-1/2 oz (410 g) || 90 mm f/3.8 lens ..... | 24-7/8 oz (705 g) |
| 127 mm f/3.8 lens ..... | 23-1/8 oz (655 g) |

## ■ Features of Mamiya RB 67

www.ianbfoto.com

The Mamiya RB 67 is part of a unique camera system developed by Mamiya Camera Company, the recognized world leader in large format photography. It takes its place alongside the famous Mamiya Press and Mamiya C Professional cameras.

Equipped with the many following features, you can use to full advantage this large format, single-lens reflex camera not only in general photography but also in fields covering fashion, commercial, scientific, news and industrial applications.

The 6×7 cm negative format offers an ideal full negative ratio for 8×10 inch enlargements as well as larger photographic prints, no cropping is necessary when making blow-ups. This ensures you more effective use of the full negative and sharper pictures due to lesser degree of enlargement.

### **The revolving adapter (turning a full 90°) allows choice of vertical or horizontal picture format**

The Mamiya RB 67 enables you to quickly change the format direction by revolving the back of the camera instead of changing the camera position, a feature extremely convenient in photographing with the camera mounted on a tripod, or even hand held.

### **Single-lens reflex system without parallax**

The greatest feature of a single-lens reflex camera—that of being able to photograph exactly what you see on the focusing screen—turns out to be very effective when combined with the convenient close-up capability of the Mamiya RB 67.

### **Excellent Mamiya Sekor Lenses with built-in lens shutter (Seiko # 1)**

The between the lens-shutter synchronizes with electronic flash at all shutter speeds.

All Mamiya Sekor Lenses from the 50 mm wide angle to the 360 mm telephoto, offering excellent image quality and superb resolving power, are equipped with an automatic aperture control feature. The lenses also have a depth of field preview lever so that the depth of field at any aperture setting is plainly visible.

4

### **Various film holders can be used by changing the back adapter**

In addition to the film holders for the Mamiya RB 67, there is a back adapter for attaching accessories of the Mamiya Press or Mamiya Universal. Especially useful is the Polaroid® Land pack film holder, for the Mamiya Universal, which lets you to see a finished picture on the spot—seconds later—adding versatility to the camera for news photography where speed is required, and for fashion photographs, scientific, commercial, or industrial photography in prechecking composition and/or exposure setting. This camera is designed to easily accommodate many accessories, offering unusual convenience and versatility.

### **Roll film holder for Mamiya RB 67 with safety device**

The camera is equipped with a safety device to prevent releasing the shutter while the dark slide is in the holder nor does it permit the holder to be removed while the dark slide is out.

### **Close-up photography by extending the camera bellows**

As with the versatile Mamiya C Series cameras, you can make interesting close-up photographs without using extension tubes merely by extending the camera bellows up to its full 46 mm extension. When using RB 67 auto-extension tubes, life-size, 1:1 close-up photography is possible.

### **Additional features**

- \* Lenses are quickly and positively interchanged with the RB 67 bayonet safety ring system.
- \* Since the focusing hood is easily interchangeable, you can easily switch to an eye-level finder or a magnifying hood depending on your needs.
- \* In addition to the standard Fresnel lens focusing screen, also available are focusing screens with rangefinder spot, microprism, cross hair, or checker grid. Select and change to the screen to suit your specific purpose in a matter of seconds.
- \* There are three types of roll film holders, one for 120 and one for 220 roll films (6×7 cm format), and one for 120 roll film 6×4.5 cm format.  
A rapid film advance lever (one-stroke film advance) permits quick shooting.
- \* Dry plate or cut film can be used with the RB 67 double cut film/plate holder.
- \* Independent mirror-release photography is also possible when needed.
- \* A quick-shoe is available for mounting the camera quickly on a tripod.
- \* Graflok back film holders made by Graflex can also be used.

## ■ Names of Parts for Operation



1. Shutter cocking lever
2. Carrying strap lug
3. Name plate
4. Lens mounting index mark
5. Focusing knob
6. Distance graduation
7. Distance scale
8. Shutter release lock ring
9. Shutter release button
10. Mirror

6

11. Magnifier lever
12. Magnifier
13. Focusing screen
14. Index dot
15. Horizontal format index mark
16. Vertical format index mark
17. Slide lock

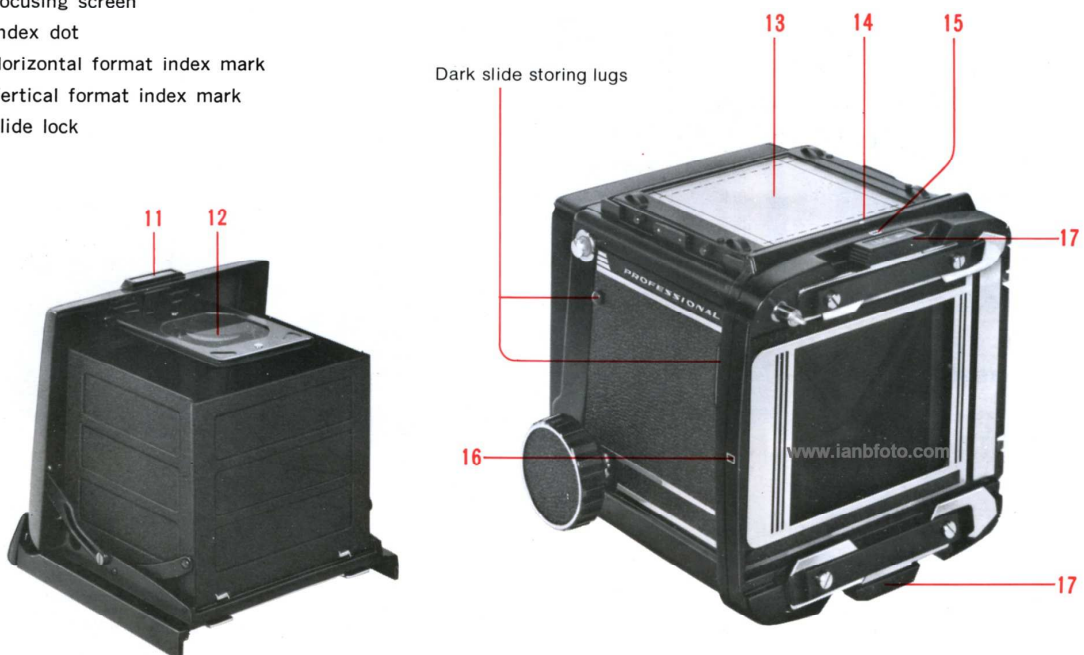

7

## ■ Names of Parts for Operation (cont.)

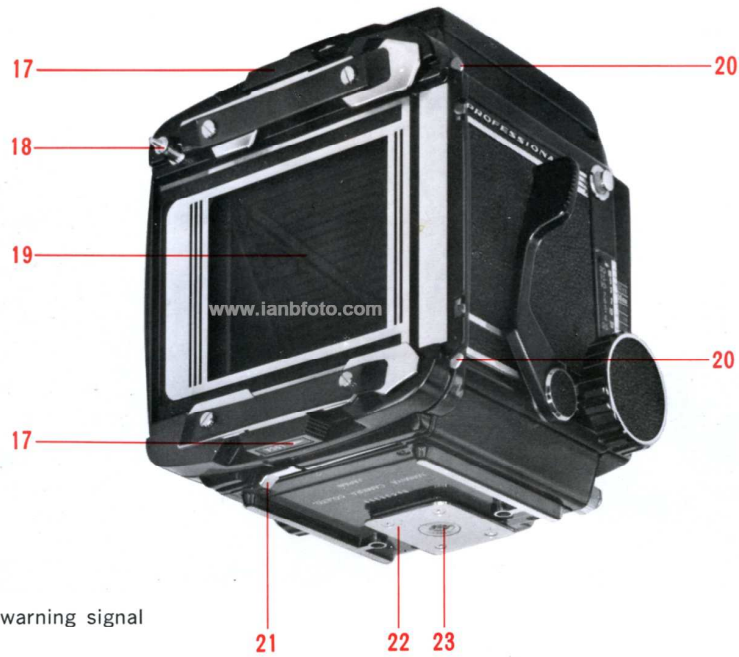

- 17. Slide lock
- 18. Coupling pin for warning signal
- 19. Light baffle
- 20. Release lever for slide lock
- 21. R-lock lever
- 22. Tripod mounting base
- 23. Tripod socket

8

## ■ Rear Body Cap



- 24. M-X selector
- 25. Synchroflash terminal
- 26. Bayonet ring
- 27. Aperture ring
- 28. Shutter speed ring
- 29. Distance scale ring for depth of field scale
- 30. Depth of field scale
- 31. Depth of field preview lever
- 32. Mirror release operating knob
- 33. Shutter release lock pin
- 34. Shutter cocking pin
- 35. Cocking position marks



### How to detach the rear body cap of the camera body

By moving the slide locks (17) on both sides fully to the left, the cap can be removed.

When the rear body cap is attached to the camera body, the shutter release button sometimes cannot be moved; in this case, remove the rear body cap.

Never push the light baffle (19) on the camera back after removing the rear body cap. If the light baffle is pushed by force, it will cause light leakage.

9

## ■ Attaching and Removing Lenses

### Attaching the Lens

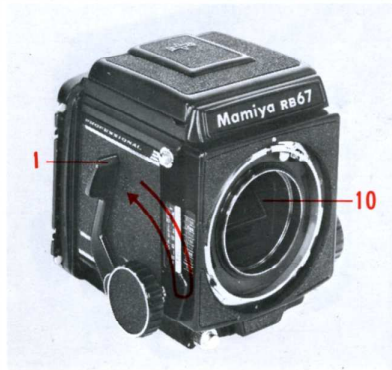

1. Remove the front body cap from the camera body.

2. Be sure that the mirror (10) is in the cocked, down position in the camera body, shielding the camera film plane from exposure to light.

If the mirror is up, cock the mirror by fully pushing down the shutter cocking lever (1) toward the front of the camera.

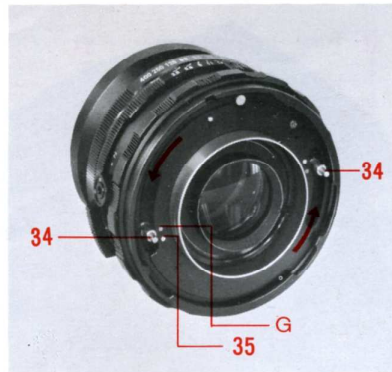

3. Remove the rear cap of the lens.

4. Cock the shutter of lens. Firmly turn the shutter cocking pins (34) with your fingers, to the red cocking position marks (35). Now the shutter blades are open. When removing your fingers from the pins, the cocking pins will turn back to the green marks (G).

**NOTE:**

When cocking the shutter, be sure to turn until the pins are aligned with the red marks. The shutter will not be cocked if turned only to the green marks.

After removing the lens from the camera body, the shutter is always cocked.



5. Then turn the bayonet ring (26), and align the red mark on the bayonet ring with the triangular mark at the center.

6. Mount the lens keeping the triangular mark aligned with the lens mounting mark (4), then firmly twist the bayonet ring clockwise. Now, the camera and shutter have been set.

10

**NOTE:**

Lens installation is possible even if the mirror and/or the shutter are/is not set; however, operations in the table must be followed to obtain a normal set condition.

Always pull out the dark slide of the film holder after setting the camera to a normal condition.

However, when the shutter release button is necessarily pressed with the roll film holder for Mamiya RB 67 attached, as shown in "1" of the table, slightly pull out the dark slide and then press the shutter release button.

	Mirror Condition	Shutter Blade Condition	Operation
<b>1</b>		 Closed	
<b>2</b>		 Opened or Closed	

### Removing the Lens



1. Press the shutter cocking lever down fully.

2. Turn the bayonet ring counterclockwise, aligning its red mark with the lens mounting mark (4) on the body, and remove the lens.

If you attempt to remove the lens with the mirror in the up position, the camera safety interlock mechanism is engaged which does not permit the lens bayonet ring from turning fully to the dismount position. Cocking the camera, which lowers the mirror and protects the film plane from accidental light leak, disengages this safety mechanism permitting lens removal easily.

It is advisable to release the shutter when the lens is not to be used for several days or longer.

### Releasing the Shutter :

To release a lens shutter which is removed from the camera body, turn the cocking pins (34) clockwise, while pressing the shutter lock pin (33) with a finger. The cocking pins should be turned all the way, do NOT leave the pins turned only halfway.



## ■ Shutter Operation



1. Align the scales on the shutter speed ring (28) and the aperture ring (27) with the red dot on the center of the lens barrel.

Always set the shutter speed to the click stop position. In-between shutter speeds cannot be used. However, the fully automatic diaphragm can be set at full and half click stops.

If the shutter speed is changed, after cocking the shutter, do not turn the shutter speed ring rapidly.

When not using flash, the M-X selector lever (24) can be set to either M or X; however, never set the lever between M and X.

When switching the M-X selector, move the lever to the right or left, while pressing the lever against the lens barrel.



2. Press down the shutter cocking lever (1). The shutter in the mounted lens and the mirror in the camera body are cocked simultaneously. The lever will return to its original position by self-action.

If the lever is depressed by 45° or more (but not fully), the lever will remain there without returning to its original position.

Once the shutter is cocked, the cocking lever will not move until the shutter is released by pushing the shutter release button. Therefore, when the cocking lever will not move, you know the shutter is cocked.

3. To release the shutter, press the shutter release button (9). If the shutter and the mirror are not cocked, the shutter release button cannot be pressed. The socket inside the shutter release button is threaded so that a cable release or a self-timer can be easily attached.

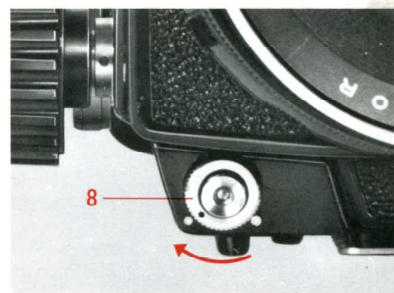

By turning the shutter release lock ring (8) and aligning the index mark with the orange-yellow dot on the camera body, the shutter release button cannot be pressed. This device prevents accidentally releasing the shutter while carrying the camera in its case.

### NOTE:

If the slide lock (17) of the revolving adapter is not pushed fully in or out, you may not be able to press the shutter release button. Always shift the slide lock until it comes to a halt.

### Time Operation

By setting the shutter speed scale on T (time) and releasing the shutter, the shutter will remain open for an extended time exposure. To close the shutter, turn the shutter speed ring toward the 1 sec. marking or press down the shutter cocking lever about 30°; however, do not move the shutter cocking lever until just before closing the shutter.

12

## ■ How to Handle the Focusing Hood



### How to raise the focusing hood

By raising the back side of the hood, the whole focusing hood will automatically spring into position.

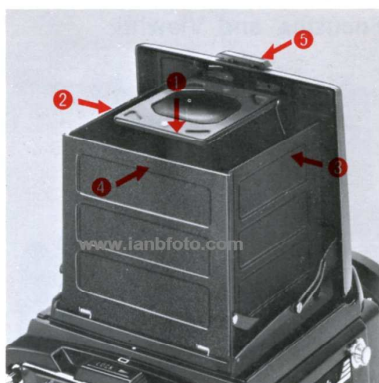

### How to fold the focusing hood

With the magnifier in its closed position, fold down the two side panels, next the back panel, and then fold the front panel to cover the other three panels.

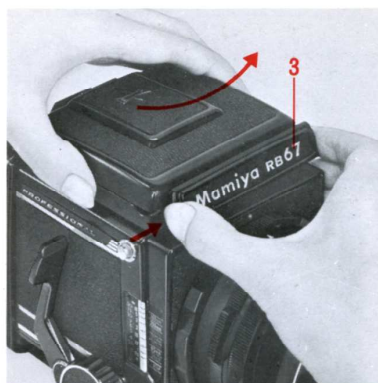

### How to attach or detach a focusing hood

By sliding the name plate (3) to the right (viewed from the front of the camera) and raising the front of the focusing hood, the hood can be detached. To reattach it, insert the two prongs on the back of the focusing hood into the grooves of the camera body, press the front of the focusing hood down firmly, and slide the name plate to its original position.

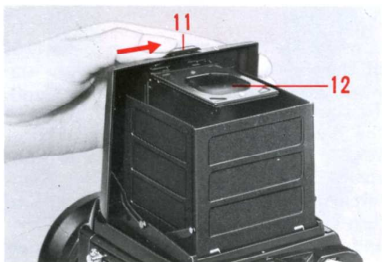

### How to raise the magnifier

By sliding the magnifier lever (11) in the direction of the arrow, the magnifier will automatically pop up. To close it, depress the frame of the magnifier back down to the front panel of the focusing hood, the magnifier will hook in place.



## ■ Focusing Screen



Various types of framed focusing screens are available for the photographer's convenience.

First remove the focusing hood, then take out the focusing screen (13) while holding both sides. To attach it, hold each side and insert the focusing screen into the top of the camera body and press down lightly.

### How to view the focusing screen

A vertical picture format is indicated by solid lines and a horizontal picture format is indicated by dotted lines on the focusing screen.

## Focusing and Viewing

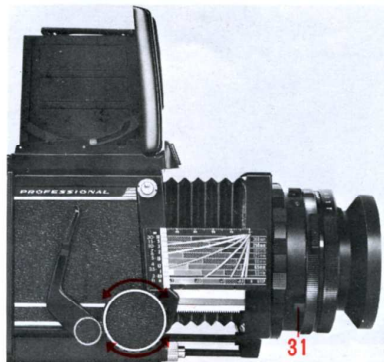

When the focusing hood is open, and the shutter is cocked, an image is visible on the ground glass of the focusing screen (13).

Turn the focusing knob (5), adjust the focus, and compose the picture. Depth of field of the aperture becomes visible on the ground glass focusing screen by fully depressing the depth of field preview lever (31) on the lens. When removing your finger, the lever will return to its original position and the lens aperture will fully reopen.

## Revolving Adapter



When the horizontal format mark (15) of the revolving adapter is facing upward, a horizontal format will result. To compose a vertical photograph, turn the revolving adapter clockwise until it stops. To change from vertical to horizontal, turn the revolving adapter counterclockwise. In either case, be sure to turn the adapter a full 90° until it clicks and stops. If the adapter is stopped halfway, the shutter release button cannot be pressed.

### NOTE:

Do NOT turn the revolving adapter while the shutter release button is being pressed.

14

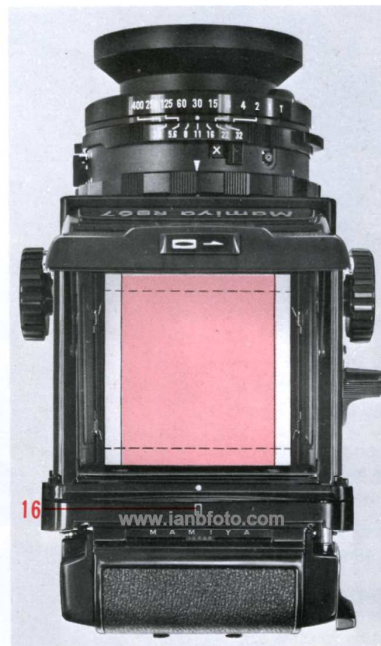

### How to attach or detach the revolving adapter

To detach the revolving adapter, pull out and down on the R-lock lever (21) at the bottom of the camera body.

To attach the revolving adapter to the camera body, face the white index dot (14) on the adapter toward the top of the camera body, and fully push the R-lock lever up.

## ■ How to Use the Lens Hood



This lens hood can be used commonly for the 90mm, 127mm, 180mm, and 250mm lenses.

1. Screw the attachment ring into the front of the lens mount.
2. Pull the folded rubber hood straight out, using it as the hood for the 127mm, 180mm, and 250mm lenses.
3. For the 90mm lens, fold the hood back halfway.

To fold the hood, pull it straight out, place the hood on a flat surface, and push down from the top to easily fold the lens hood.

You can also leave the hood on the lens for portability by pushing back and turning out the hood while it is attached to the lens.

A filter can be screwed in between the lens and the hood, or in front of the lens hood.

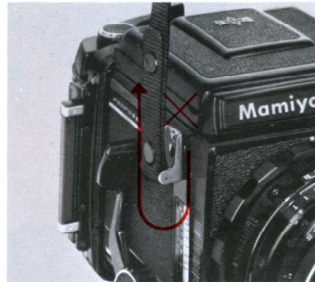
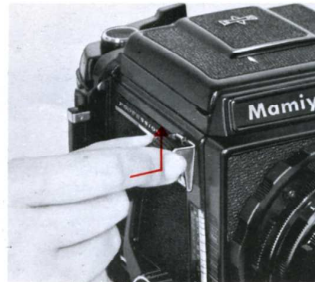

## Carrying Strap

### Attaching

While holding both sides of the strap attaching metal, slide the attaching metal toward the hanging direction, after fitting and pressing the round hole on the metal back side to the lug for strap on the camera body.

### Note:

Always attach and use the strap so that it and the strap attaching metal are straight.

When changing the strap hanging direction, always reattach the strap.

### Detaching

To detach the strap, slide the attaching metal in reverse direction to attaching, while slightly raising the leaf spring on the attaching metal with a finger tip.

16

## ■ Attaching and Detaching the Roll Film Holder

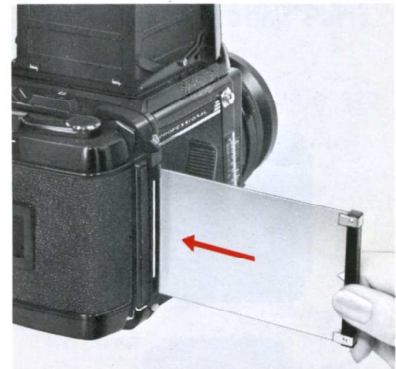

### Attaching

1. To attach the holder, the slide locks (17) on the top and bottom of the camera have to be at the left ends of the slots. If the slide locks are in the center, push the slide lock release levers (20) and push both slide locks in the opposite direction of the arrow (▶).

2. Then attach the roll film holder and slide both slide locks firmly in the direction of the arrow (▶).

### NOTE:

Be sure to attach the roll film holder from the back to prevent it from hitting the warning mark coupling pin (18) of the holder.

Should either slide lock be moved while nothing is attached to the revolving adapter, the slide lock release lever will engage and the slide lock will not move. If this happens, press the release lever and return the slide lock to the open position.

### Detaching

1. Insert a dark slide in the roll film holder.

Two white lines on the side of the holder indicate the position of the inserting slit.

2. Remove the roll film holder by sliding both slide locks in the opposite direction of the arrow (▶).

If the dark slide is not inserted, the slide locks will not move.

17

## ■ Roll Film Holder Safety Devices

The following safety devices function when the Mamiya RB67 roll film holder is attached to the camera.



1. The shutter release button cannot be pressed while the dark slide is in the holder.

If the dark slide is pulled out slightly, the shutter release button can be pressed. This operation can be utilized for shutter testing. In this case, the double-exposure warning signal turns red. When the holder is loaded, do not pull out the dark slide beyond the tip of the triangular hole in the top center of the dark slide, otherwise the film may be fogged.

2. When a dark slide is completely inserted, the slide lock release lever (20) is automatically released, and the slide locks (17) can be slid without pressing the release levers.

On the other hand, if the dark slide is not inserted, the slide locks will not move unless the release lever is pressed. This prevents accidentally removing the film holder from the camera and fogging the film.

18

## ■ Handling the Roll Film Holder

### Types of Roll Film Holder

There are three types of roll film holders.

For 6 × 7cm; 120 roll film	10 exposures
For 6 × 7cm; 220 roll film	20 exposures
For 6 × 4.5cm; 120 roll film	16 exposures

Although the outer cassette of 6 × 7 roll film holders are the same, the film inserts are designed for one size film only. The difference is indicated by the film type index marked on the film insert.

All types of holders are used the same way; however, special instruction for the 6 × 4.5 roll film holder are given on page 23.



### Name of Operating Parts

- R 1 Dark slide
- R 2 Film type index (120 or 220)
- R 3 Film advance lever
- R 4 Exposure counter
- R 5 Warning signal window

### Outer cassette

- R 6 Memo clip
- R 7 Back cover
- R 8 Back cover latch

### Film insert

- R 9 Film wind-stop release lever
- R 10 Spool release pin (left)
- R 11 Film spool stud
- R 12 Starting mark
- R 13 Spool release pin (right)
- R 14 Take-up spool stud

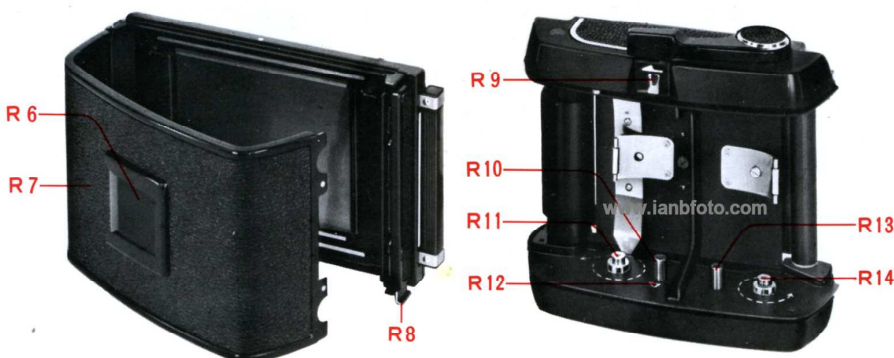

19

## ■ Loading Film

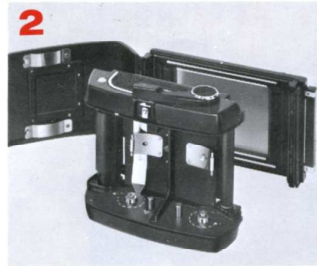
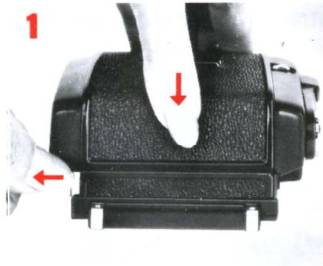

When loading and unloading film, avoid direct sunlight. Use a location in the shade.

1. Open the back cover by pulling out the back cover latch, while slightly pressing the back cover.

2. Remove the film insert from the holder.

3. By pressing the right side spool release pin (R 13), the take-up spool stud (R 14) will retract. At this point, insert an empty spool on the take-up shaft.

4. Next, while pressing the left side spool release pin (R 10), insert a new roll of film on the film spool stud.

Load the film so that the leader paper can be pulled out in the arrow direction. In this way, the black side of the leader paper will appear on the outside. (If the black side does not appear on the outside, reload the film, reversing the film position.)

5. Pull out the leader paper and insert the tip into the groove of the take-up spool. Position the film so that the leader paper is winding evenly between the spool flanges; otherwise the film may be taken up unevenly, causing trouble.

6. Move the film advance lever (R 3) gently, until the starting mark (arrow) of the leader paper aligns with the starting mark (R 12) of the holder. The film advance lever can be moved in several short, definite strokes.

**NOTE:** If the leader paper is pulled too far, the film may become fogged. Be careful not to go beyond the starting mark (arrow).

20

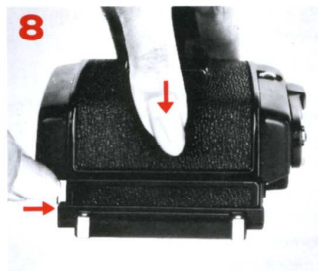

7. Put the insert into the cassette aligning the top side of the insert with the white dot of the cassette.

8. When the film insert is in position, close the back cover and fully push in the back cover latch while pressing the back cover.

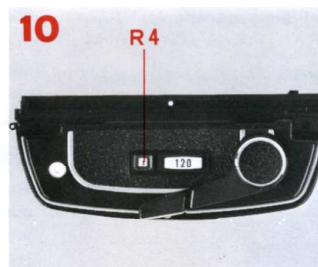

9. The clip (R 6) on the back cover can be used for holding the cover of a film box or a slip of paper to record information.

10. Wind the film advance lever until it stops, the figure "1" will appear in the exposure counter (R 4), indicating the film is in position ready for the first exposure.

**NOTE:** Wind the film advance lever in a slow steady manner to avoid film winding problems.

## ■ Photographing



1. Attach the loaded holder to the camera and pull out the dark slide (R 1).
2. Adjust the focus, determine the exposure setting, and release the shutter. (The shutter release button cannot be pressed unless the dark slide is removed.)
3. When the shutter is released, the double-exposure warning signal (R5) turns red. Move the film wind-stop release lever (R 9) in the direction of the arrow, wind the film advance lever until it stops, and prepare for the next photograph. As soon as the release lever (R 9) is moved, the warning signal turns white.

**NOTE:** Do not remove your finger from the shutter cocking lever until you have completed the full winding action.

If you move the shutter cocking lever a trifle and then remove your finger from the lever, the warning signal will turn red even if no picture has been taken.

### Multiple Exposure Photography

By cocking the shutter and repeating exposures without advancing the film (even though the warning signal is red), fascinating multiple exposures can be created.



### Dark Slide Storing Method

By inserting it from above, the dark slide can be stored on the side of the camera body.

### Unloading Film

1. When you finish exposing the full number of exposures, the film advance lever will be freed. Then wind the film completely to the end of the leader paper.
2. Open the back cover of the holder and remove the film insert. Press the spool release pin (R 13), remove the full spool, then wrap and seal the film to protect it from loosening.
3. Move the empty spool to the take-up side. The insert is ready for reloading.

The exposure counter (R 4) automatically resets to S (start) as soon as the back cover is opened. When the exposure counter shows other than S, a film is loaded in the holder.

22

## ■ 120 Roll Film Holder 6 × 4.5



The operating method is the same as the 6 × 7 roll film holder, except for the following instructions.

### Field of View

A field of view for the 6 × 4.5 format and the format direction can be ascertained through the finder mask and format index mark on the roll film holder.

### Attaching the Finder Mask

1. Remove the focusing hood from the camera body.
2. Slightly curve up the finder mask by bearing on the lugs on the mask with the finger tips; then insert the four corners of the mask under the leaf springs on the focusing screen frame as shown in the photo.

Attach the mask so that the triangular hole is positioned on the upper, left corner, viewed from the camera rear. This hole gives access to reading the exposure meter needle when the CdS Finder is attached.

3. Reattach the focusing hood.

### Horizontal and Vertical Format Marks

When using this roll film holder, distinction between a horizontal and vertical format to be photographed is made by the format marks on the upper side or the left side on the holder (instead of the marks for 6 × 7 format on the revolving adapter). The area to be photographed can be distinguished by the finder mask as shown in the photos.

In addition, when viewed from the rear side, the frame on the back cover — symbolized by a 6 × 4.5 format — indicates direction of the format in accordance with revolving the back.



23

## Distance Scale

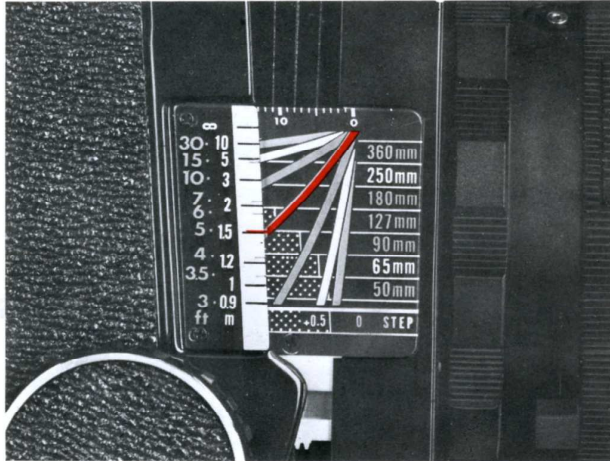

Distance from the film plane to the subject can be determined by the distance scale (7).

Curves on the distance scale are represented in a different color for each lens. The figure on the distance graduation (6) which meets the curve for the lens used after focusing reveals the distance to the subject.

For example, if the distance graduation and the curve are as shown in the photo after focusing with the 127 mm lens, you can confirm that distance to the subject is 5 ft by reading the graduation aligned with the orange curve.

## Close-up Photography

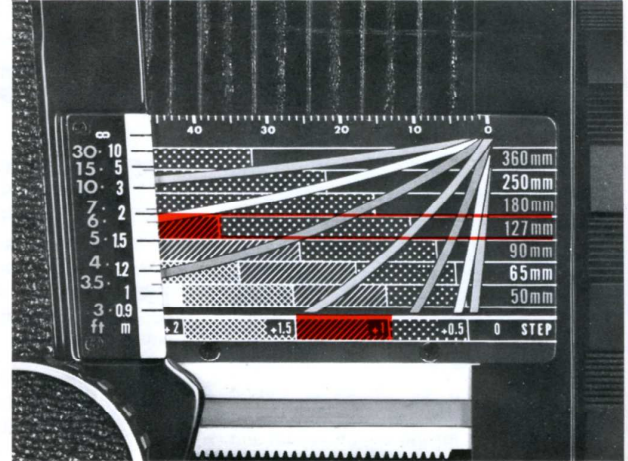

Maximum Close-up Photography Table

Lens	Lens-to-subject distance	Magnification	Subject coverage
50mm f/4.5	1 $\frac{1}{16}$ " ( 4.9cm)	0.88	2 $\frac{1}{2}$ " $\times$ 3 $\frac{1}{8}$ " ( 6.4 $\times$ 7.8cm)
65mm f/4.5	3 $\frac{3}{16}$ " ( 8.0cm)	0.71	3 $\frac{3}{16}$ " $\times$ 3 $\frac{1}{8}$ " ( 8.0 $\times$ 9.7cm)
90mm f/3.8	7 $\frac{3}{16}$ " (19.8cm)	0.51	4 $\frac{3}{8}$ " $\times$ 5 $\frac{1}{8}$ " (11.1 $\times$ 13.5cm)
127mm f/3.8	1' 5 $\frac{3}{16}$ " (43.4cm)	0.36	6 $\frac{3}{16}$ " $\times$ 7 $\frac{1}{8}$ " (15.5 $\times$ 18.9cm)
180mm f/4.5	2' 9 $\frac{3}{16}$ " (84.7cm)	0.26	8 $\frac{1}{16}$ " $\times$ 1' $\frac{1}{16}$ " (22.0 $\times$ 32.5cm)
250mm f/4.5	5' 3"	0.18	1' $\frac{1}{16}$ " $\times$ 1' 2 $\frac{3}{16}$ " (30.6 $\times$ 37.2cm)
360mm f/6.3	11' 4 $\frac{1}{4}$ " (346 cm)	0.13	1' 5 $\frac{3}{16}$ " $\times$ 1' 9 $\frac{1}{8}$ " (44.0 $\times$ 53.6cm)

The lens-to-subject distance represents the distance of the subject from the front edge of the lens barrel.

24

## Using a Tripod

### Exposure compensation for close-up photography

When the bellows is extended for close-up photography and the distance between the lens and the film plane increases beyond normal, an increase in exposure is required.

To adjust the exposure, use the exposure compensation scale appearing on the distance scale (7). The exposure compensation scale shows an index for each lens marked in 1/2 steps.

Focus on the subject and note the pattern of the scale where the distance scale for the lens meets the distance scale graduation plate edge. The compensating value is shown below.

Read the compensating value of the same pattern, and increase the exposure accordingly. For example, when the scale shows the pattern as shown in the photo when focused on a certain subject, exposure needs to be increased by one step. If your exposure meter shows the exposure setting of 1/60 sec. at f/16, the setting must be adjusted to 1/30 sec. at f/16 or to 1/60 sec. at f/11.

One exposure step corresponds to one step on the aperture scale or one step on the shutter speed scale. For 0.5 step compensation, use the in-between aperture scale settings.

When using the CdS finder for the Mamiya RB, exposure need not be compensated, since the meter reads actual exposure directly.

#### NOTE:

When using the 50mm and 65mm lenses closer than 3  $\frac{1}{4}$  ft (1 meter) it is necessary to use a lens aperture of f/16, or smaller, in order to obtain satisfactory lens performance.

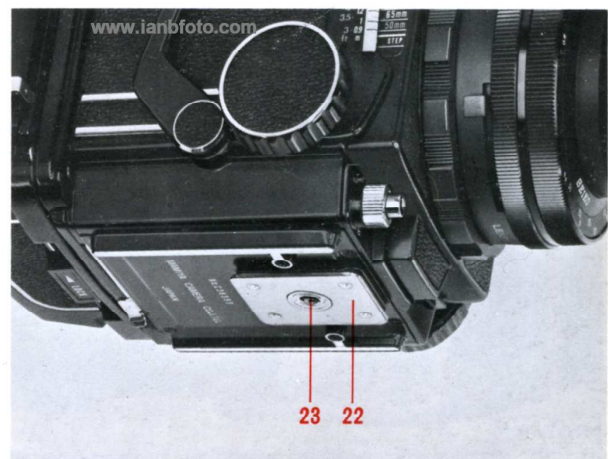

For maximum picture sharpness the use of a sturdy tripod is recommended. Insert the tripod screw into the tripod socket (23) at the bottom of the camera.

When a tripod with a 3/8 inch tripod screw is used, remove the inner socket by turning the tripod socket counterclockwise with a coin or similar disk inserted in the slots of the socket. The standard tripod has a 1/4 inch tripod screw and can be used for this camera in conjunction with the inner tripod socket.

### Tripod Mounting Base

The tripod mounting base (22) at the bottom of the camera is for attaching a quick shoe. If you keep a quick shoe on your tripod head, the camera can be quickly and easily mounted on it.

25

## Close-up Photography with the Auto Extension Tubes



Attaching and detaching the auto extension tubes is accomplished in the same manner as with the lens. When initially mounting a lens to the extension tube, cock both the lens and the tube. The auto extension tubes couple with the automatic aperture of the lenses.

### NOTES :

1. For exposure compensation, refer to the following table. Reading of the exposure compensation scale differs from that when not utilizing extension tubes.
2. For close-up photography, we recommend independent mirror-releasing prior to each actual photograph. This omits or minimizes any residual camera body movement due to mirror action.
3. When photographing through the extension tubes, use as small an aperture as possible.
4. When photographing in the 6×7 size, if the 127mm lens is used, minimal or no corner vignetting will occur, however, when using lenses other than the 127mm lens with two extension tubes (No. 1 and No. 2), the possibility of some vignetting in the four corners of the picture may occur. When using only one extension tube, no vignetting will occur with any lens.
5. When photographing with the Polaroid Land film pack, corner vignetting increases due to the larger picture size, however a 6×7cm portion in the center of the photo will be essentially clear of vignetting.
6. Use only one auto extension tube No. 1 for the 65mm lens.
7. Since it will decrease resolving power due to exceeding life-size, do not use the auto extension tube with the 50mm lens.

1. Distance indicates the distance from the front edge of the lens barrel to the subject.

2. Subject coverage is the size of the subject to be photographed on the film.

3. The figures in the left column of the close-up table indicate no bellows extension. The figures on the right indicate when the bellows is extended to the maximum (46mm).

### How to Find the Exposure Compensation Value

1. After focusing the lens, read the extension amount through the bellows extension scale on the top of the distance scale.
2. Find the compensation value by the "Bellows extension scale/Exposure compensation value" located on the right side of the close-up photography table.

For example, assume that 127mm lens is focused after combining it with No. 2 auto extension tube. If the extension amount reads 35mm by the bellows extension amount scale, it is understood that the compensation value is +2 steps by the scale located on the right side of the close-up photography table. In this case, increase exposure by setting the shutter speed dial at two steps slower or by opening the aperture by two steps.

26

Lens	Extension tube	Magnification	Distance	Subject coverage	Bellows extension scale (mm)	
					Exposure compensation value (STEP)	
65mm F4.5	No. 1	0.69~1.40	$3\frac{7}{32}'' \sim 1\frac{11}{32}''$ (8.2~3.4)cm	$3\frac{7}{32}'' \times 3\frac{29}{32}'' \sim 1\frac{1}{16}'' \times 1\frac{1}{16}''$ (8.2×9.9)cm~(4.0×4.9)cm	40 30 20 10 0 +2.5      +2      +1.5	
	No. 2	0.50~1.00	$7\frac{1}{16}'' \sim 4\frac{1}{32}''$ (20.2~11.0)cm	$4\frac{7}{16}'' \times 5\frac{7}{16}'' \sim 2\frac{7}{32}'' \times 2\frac{1}{16}''$ (11.3×13.8)cm~(5.6×6.8)cm	40 30 20 10 0 +2      +1.5      +1	
90mm F3.8	No. 2	0.90~1.41	$4\frac{25}{32}'' \sim 3\frac{5}{16}''$ (12.0~8.4)cm	$2\frac{7}{16}'' \times 3'' \sim 1\frac{9}{16}'' \times 1\frac{1}{16}''$ (6.2×7.6)cm~(4.0×4.9)cm	40 30 20 10 0 +2.5      +2	
	No. 1 + No. 2	1.41~1.91	$3\frac{5}{16}'' \sim 2\frac{5}{8}''$ (8.4~6.7)cm	$1\frac{9}{16}'' \times 1\frac{1}{16}'' \sim 1\frac{3}{16}'' \times 1\frac{1}{32}''$ (4.0×4.9)cm~(3.0×3.6)cm	40 30 20 10 0 +3      +2.5	
127mm F3.8	No. 1	0.35~0.71	$1' 5\frac{3}{8}'' \sim 10\frac{1}{4}''$ (44.1~26.0)cm	$6\frac{1}{4}'' \times 7\frac{19}{32}'' \sim 3\frac{3}{8}'' \times 3\frac{25}{32}''$ (15.9×19.3)cm~(7.9×9.6)cm	40 30 20 10 0 +1.5      +1	
	No. 2	0.65~1.01	$11\frac{1}{32}'' \sim 8\frac{7}{32}''$ (28.0~20.9)cm	$3\frac{1}{16}'' \times 4\frac{3}{16}'' \sim 2\frac{7}{32}'' \times 2\frac{1}{16}''$ (8.7×10.6)cm~(5.6×6.8)cm	40 30 20 10 0 +2      +1.5	
	No. 1 + No. 2	1.00~1.36	$8\frac{9}{32}'' \sim 6\frac{5}{16}''$ (21.0~17.6)cm	$2\frac{7}{32}'' \times 2\frac{1}{16}'' \sim 1\frac{5}{8}'' \times 1\frac{31}{32}''$ (5.6×6.8)cm~(4.1×5.0)cm	40 30 20 10 0 +2.5      +2	
180mm F4.5	No. 1	0.25~0.51	$2' 9\frac{31}{32}'' \sim 1' 7\frac{7}{32}''$ (86.3~49.9)cm	$8\frac{27}{32}'' \times 10\frac{5}{32}'' \sim 4\frac{3}{8}'' \times 5\frac{5}{16}''$ (22.5×27.4)cm~(11.1×13.5)cm	40 30 20 10 0 +1      +0.5	
	No. 2	0.46~0.71	$1' 9\frac{3}{16}'' \sim 1' 3\frac{1}{32}''$ (53.8~39.6)cm	$4\frac{7}{8}'' \times 5\frac{29}{32}'' \sim 3\frac{1}{8}'' \times 3\frac{25}{32}''$ (12.4×15.0)cm~(7.9×9.6)cm	40 30 20 10 0 +1.5      +1	
	No. 1 + No. 2	0.71~0.96	$1' 3\frac{21}{32}'' \sim 1' 1''$ (39.8~33.0)cm	$3\frac{3}{16}'' \times 3\frac{3}{16}'' \sim 2\frac{5}{16}'' \times 2\frac{1}{16}''$ (8.0×9.7)cm~(5.9×7.1)cm	40 30 20 10 0 +2      +1.5	
250mm F4.5	No. 1	0.18~0.36	$5' 4\frac{3}{16}'' \sim 3' 5\frac{1}{8}''$ (163~93)cm	$1' 1/16'' \times 1' 3'' \sim 6\frac{3}{32}'' \times 7\frac{19}{32}''$ (31.3×38.1)cm~(15.5×18.8)cm	40 30 20 10 0 +1      +0.5	
	No. 2	0.33~0.51	$3' 3\frac{3}{4}'' \sim 2' 4\frac{3}{4}''$ (101~73)cm	$6\frac{25}{32}'' \times 8\frac{7}{32}'' \sim 4\frac{11}{32}'' \times 5\frac{9}{32}''$ (17.2×20.9)cm~(11.0×13.4)cm	40 30 20 10 0 +1	
	No. 1 + No. 2	0.51~0.69	$2' 5\frac{1}{8}'' \sim 1' 11\frac{3}{8}''$ (74~60)cm	$4\frac{3}{8}'' \times 5\frac{5}{16}'' \sim 3\frac{3}{16}'' \times 3\frac{29}{32}''$ (11.1×13.5)cm~(8.1×9.9)cm	40 30 20 10 0 +1.5      +1	
360mm F6.3	No. 1	0.12~0.25	$11' 6\frac{3}{32}'' \sim 6' 9\frac{1}{8}''$ (352~206)cm	$1' 5\frac{21}{32}'' \times 1' 9\frac{9}{16}'' \sim 8\frac{25}{32}'' \times 10\frac{21}{32}''$ (45.0×54.8)cm~(22.3×27.1)cm	40 30 20 10 0 +0.5	
	No. 2	0.22~0.35	$7' 3\frac{1}{32}'' \sim 5' 4\frac{1}{32}''$ (222~165)cm	$9\frac{21}{32}'' \times 11\frac{7}{32}'' \sim 6\frac{7}{32}'' \times 7\frac{19}{32}''$ (24.7×30.1)cm~(15.8×19.3)cm	40 30 20 10 0 +1      +0.5	
	No. 1 + No. 2	0.35~0.48	$5' 5\frac{1}{32}'' \sim 4' 6\frac{3}{32}''$ (166~139)cm	$6\frac{3}{16}'' \times 7\frac{5}{8}'' \sim 4\frac{13}{32}'' \times 5\frac{5}{8}''$ (16.0×19.4)cm~(11.7×14.3)cm	40 30 20 10 0 +1	

## ■ How to Read Depth of Field



1. Focus on the subject, determine the aperture setting.



2. Depress the depth of field preview lever, and the depth of field can be observed on the ground glass focusing screen.



1. Turn the distance scale ring (29) and align the figure representing the focused distance with the center index mark on the depth of field scale (30).

The two distances (on both sides of the center index mark) opposite the same figures as the actual lens aperture on the depth of field scale are the near and far limits of depth for a given distance and lens aperture.

For example, when photographing a subject 15 feet away with the 90mm lens at an aperture of f/11, objects from about 30 to 10 feet will be in focus.

28

## ■ Flash Photography

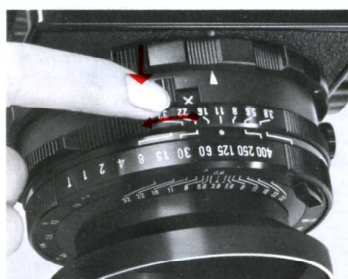

Connect the cord of the flash unit to the synchroflash terminal (25).

### M-X selection

The M-X selecting lever is internally locked to prevent unintentional switching of the mode.

When switching the synchronization mode, push the lever against the lens barrel. While pressing, turn it right or left until it reaches the end. The letter X or M, which indicates the contact type, should appear in the window.

When employing electronic flash, set the M-X selector (24) to X to synchronize flash at any shutter speed. When M-class flash bulbs are used, set the M-X selector to M to synchronize at any shutter speed. When F-class flash bulbs are used, set the selector to X and photograph at 1/60 sec. or a slower shutter speed.

The aperture setting for flash photography is determined by dividing the guide number of the bulb or the electronic flash unit by the distance.

Example

$$\frac{(\text{Guide number}) 40}{(\text{Distance to subject}) 5} = (\text{Aperture setting}) 8$$

### NOTE:

When an intensive current flows directly to the shutter due to an abnormal method of using electronic flash, the synchronizing mechanism may be damaged.

Flash Synchronization Table

Combinations with the ○ mark synchronize.  
Combinations with the × mark do not synchronize.

Contact	Bulb	Shutter speed									
		1	1/2	1/4	1/8	1/15	1/30	1/60	1/125	1/250	1/400
M	M class	○	○	○	○	○	○	○	○	○	○
X	Electronic flash	○	○	○	○	○	○	○	○	○	○
	F class	○	○	○	○	○	○	○	×	×	×
	M class	○	○	○	○	○	○	×	×	×	×



## ■ Mirror-up Photography (Independent Mirror Release)



Since a negligible shock will affect the image when using a long telephoto lens or in close-up photography, mirror-up photography is recommended.

In mirror-up photography, previously release the mirror and operate only the lens shutter at the moment of taking the photograph.

For mirror-up photography, pull out and turn the independent mirror release operating knob (32) on the lens to match the red dot of the knob against the letter M, regardless of shutter cocking condition.

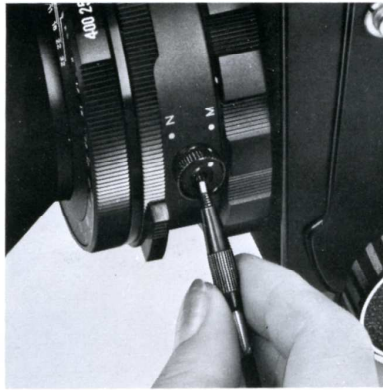

Then screw a cable release into the female screw socket in the center of the knob.

When everything is prepared, by pressing the shutter release button, the mirror and the light baffle will snap up, but the shutter will not be released.

Then release the shutter with the cable release. (When you do not have a cable release, simply turn the mirror release operating knob to N to release the shutter.)

**NOTE:** Unless the mirror release operating knob is returned to N, the camera will remain set for mirror-up photography. In this case, the film will not be exposed even when the shutter release button is pressed.

For this type of photography, an ideal mirror-up cable release is available as an optional accessory.



30

## ■ Mamiya RB 67 Operation Diagram

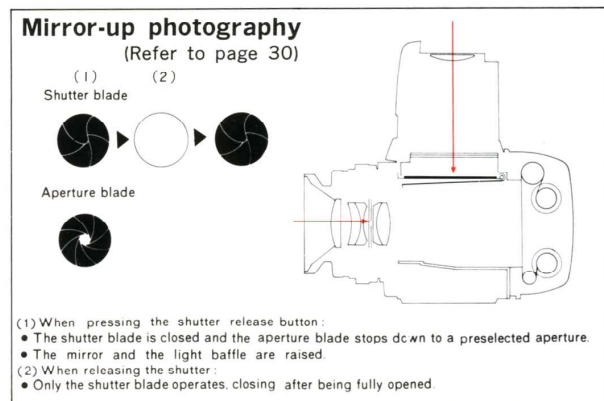
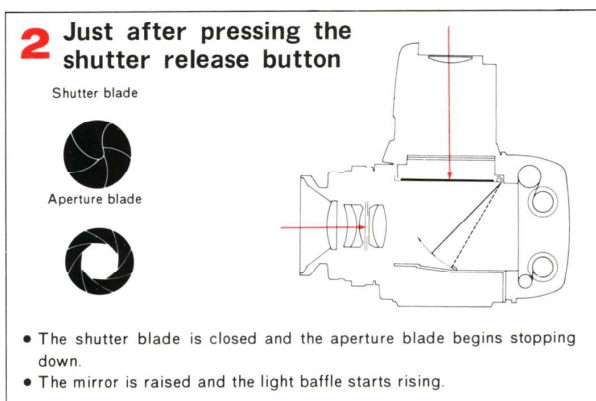
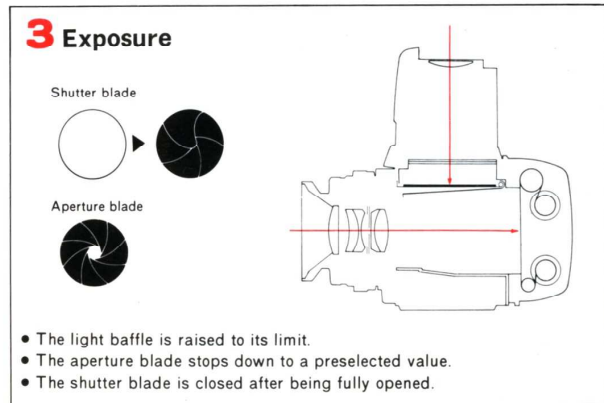
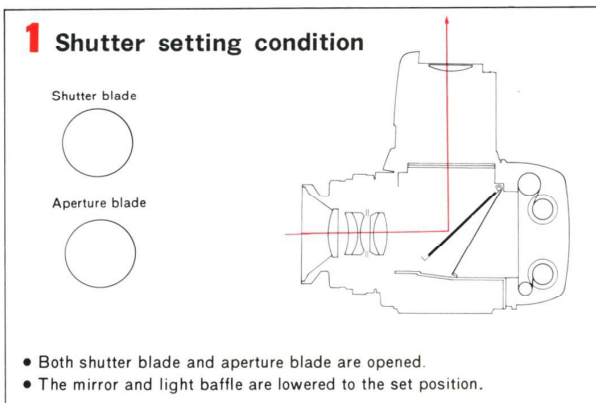

31

**■ Lens (with Seiko # 1 Shutter)**



**50<sup>mm</sup> f/4.5**

Composition: 11 elements in 8 groups  
 Picture angle: 82°  
 Minimum aperture: 32  
 Filter diameter: 77mm  
 Hood: Slip-on type  
 Weight: 32 -7/16 oz (920 g)

This lens has a built-in floating system which moves a portion of the lens system to the front or rear, according to the photographing distance, in order to obtain sharp resolution down to the picture circumference.

**Depth of Field Table**

Aperture	Distance in Meter									
	∞	10	5	4	3	2.5	2	1.5	1.2	1
4.5	6.22	3.87	2.81	2.47	2.06	1.81	1.54	1.23	1.03	0.88
	∞	∞	24.04	10.77	5.61	4.06	2.87	1.92	1.45	1.16
5.6	4.96	3.35	2.53	2.25	1.91	1.70	1.46	1.18	0.99	0.85
	∞	∞	∞	19.23	7.25	4.84	3.23	2.08	1.53	1.21
8	3.52	2.63	2.10	1.91	1.66	1.50	1.31	1.08	0.92	0.81
	∞	∞	∞	∞	17.92	7.97	4.35	2.48	1.73	1.33
11	2.51	2.03	1.70	1.58	1.40	1.29	1.15	0.97	0.85	0.75
	∞	∞	∞	∞	∞	∞	∞	8.65	3.42	2.13
16	1.79	1.53	1.35	1.27	1.16	1.08	0.98	0.85	0.76	0.68
	∞	∞	∞	∞	∞	∞	∞	7.49	3.17	2.01
22	1.28	1.15	1.04	1.00	0.93	0.88	0.82	0.73	0.66	0.60
	∞	∞	∞	∞	∞	∞	∞	∞	10.90	3.57
32	0.92	0.85	0.80	0.77	0.73	0.70	0.66	0.61	0.56	0.52
	∞	∞	∞	∞	∞	∞	∞	∞	∞	∞

**Depth of Field Table**

Aperture	Distance in Feet									
	∞	30	15	10	8	7	6	5	4	3
4.5	20' 5"	12' 3"	8' 9"	6' 10"	5' 10"	5' 3 1/2"	4' 8 3/4"	4' 1 1/4"	3' 5"	2' 8"
	∞	∞	54'	19'	12' 9"	10' 4"	8' 3"	6' 5 1/2"	4' 10 1/4"	3' 5 1/4"
5.6	16' 3"	10' 8"	7' 11"	6' 3 1/2"	5' 5 1/2"	5'	4' 5 3/4"	3' 11"	3' 3 1/2"	2' 7 1/4"
	∞	∞	∞	24' 9"	15' 1"	11' 10"	9' 2"	6' 11 1/2"	5' 1 1/2"	3' 6 3/4"
8	11' 7"	8' 5 1/2"	6' 8"	5' 6"	4' 10 1/4"	4' 5 3/4"	4' 3/4"	3' 7 1/4"	3' 3/4"	2' 5 3/4"
	∞	∞	∞	65' 2"	24' 2"	16' 8"	11' 9"	8' 4"	5' 10"	3' 10 1/4"
11	8' 2 1/2"	6' 6 1/2"	5' 5"	4' 7 3/4"	4' 2 3/4"	3' 10 3/4"	3' 7"	3' 2 3/4"	2' 9 3/4"	2' 3 3/4"
	∞	∞	∞	∞	∞	39' 10"	19' 10"	11' 8"	7' 2 1/2"	4' 4 3/4"
16	5' 10 1/2"	4' 11 3/4"	4' 3 3/4"	3' 9 3/4"	3' 6"	3' 3 3/4"	3' 1"	2' 10"	2' 6"	2' 1 1/4"
	∞	∞	∞	∞	∞	∞	∞	26' 11"	10' 11"	5' 5 1/2"
22	4' 2 3/4"	3' 8 3/4"	3' 4 3/4"	3' 3/4"	2' 10 1/2"	2' 9"	2' 7"	2' 4 3/8"	2' 2 3/8"	1' 10 1/2"
	∞	∞	∞	∞	∞	∞	∞	∞	∞	8' 6"
32	3' 1/4"	2' 9 1/4"	2' 7"	2' 4 3/8"	2' 3 3/8"	2' 2 3/8"	2' 1 3/8"	2'	1' 10 3/8"	1' 7 3/8"
	∞	∞	∞	∞	∞	∞	∞	∞	∞	∞

32

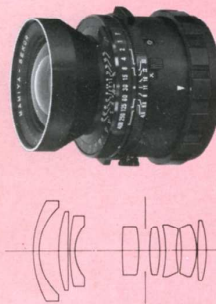

**65<sup>mm</sup> f/4.5**

Composition: 8 elements in 8 groups  
 Picture angle: 68° 10'  
 Minimum aperture: 32  
 Filter diameter: 77 mm  
 Hood: Slip-on type  
 Weight: 29.5/8 oz (840 g)

**Depth of Field Table**

Aperture	Distance in Meter									
	∞	10	5	4	3	2.5	2	1.5	1.2	1
4.5	10.8	5.27	3.48	2.98	2.40	2.08	1.73	1.35	1.11	0.939
	∞	∞	9.01	6.15	4.03	3.16	2.38	1.69	1.31	1.071
5.6	8.60	4.70	3.24	2.80	2.29	1.99	1.67	1.32	1.09	0.925
	∞	∞	11.4	7.16	4.42	3.39	2.51	1.75	1.34	1.091
8	6.12	3.87	2.83	2.50	2.08	1.84	1.57	1.26	1.05	0.898
	∞	∞	24.8	10.8	5.53	3.98	2.81	1.88	1.42	1.134
11	4.36	3.10	2.41	2.17	1.86	1.66	1.44	1.18	0.99	0.862
	∞	∞	∞	38.5	8.64	5.33	3.39	2.11	1.53	1.203
16	3.12	2.44	2.00	1.83	1.61	1.47	1.30	1.08	0.93	0.817
	∞	∞	∞	∞	∞	10.4	4.84	2.56	1.74	1.317
22	2.24	1.88	1.62	1.51	1.36	1.26	1.14	0.97	0.85	0.762
	∞	∞	∞	∞	∞	∞	12.8	3.70	2.16	1.529
32	1.62	1.44	1.29	1.22	1.13	1.06	0.97	0.86	0.77	0.697
	∞	∞	∞	∞	∞	∞	∞	10.8	3.37	2.001

**Depth of Field Table**

Aperture	Distance in Feet									
	∞	30	15	10	8	7	6	5	4	3.5
4.5	35' 4"	16' 6"	10' 9"	7' 11 1/2"	6' 8"	5' 11 1/2"	5' 3"	4' 5 3/4"	3' 8 1/4"	3' 3 3/4"
	∞	186'	25' 2"	13' 6"	10'	8' 5 1/2"	7'	5' 7 1/2"	4' 4 1/4"	3' 9 3/4"
5.6	28' 2"	14' 9"	10'	7' 7"	6' 5"	5' 9"	5' 1"	4' 4 1/2"	3' 7 1/4"	3' 2 3/4"
	∞	∞	30' 7"	14' 10"	10' 9"	8' 11 1/2"	7' 4"	5' 10"	4' 6"	3' 10 1/4"
8	20' 1"	12' 3"	8' 10"	6' 11"	5' 11"	5' 4 1/2"	4' 9 1/2"	4' 2"	3' 5 3/4"	3' 1 1/4"
	∞	∞	54' 8"	18' 8"	12' 6"	10' 2"	8' 1"	6' 3 1/2"	4' 8 3/4"	4' 1/4"
11	14' 4"	9' 11"	7' 7"	6' 1 1/2"	5' 4 1/2"	4' 11 1/4"	4' 5 1/4"	3' 11"	3' 3 1/2"	2' 11 1/2"
	∞	∞	∞	29' 9"	16' 6"	12' 6"	9' 6"	7' 1"	5' 1 1/2"	4' 3 3/4"
16	10' 3"	7' 10"	6' 4"	5' 3 1/2"	4' 9"	4' 5"	4' 1/4"	3' 7"	3' 1"	2' 9 3/4"
	∞	∞	∞	∞	30' 8"	19' 1"	12' 8"	8' 7 1/2"	5' 10"	4' 9"
22	7' 4"	6' 1"	5' 2"	4' 6"	4' 1 1/4"	3' 10 3/4"	3' 6 3/4"	3' 2 3/4"	2' 10"	2' 7 1/4"
	∞	∞	∞	∞	∞	24' 10"	12' 8"	7' 4"	4' 7 1/2"	3' 11 1/2"
32	5' 4"	4' 7 3/4"	4' 1 1/2"	3' 8 1/2"	3' 5 1/2"	3' 3 3/4"	3' 1"	2' 10 1/4"	2' 6 1/4"	2' 4 1/2"
	∞	∞	∞	∞	∞	∞	∞	41'	11' 8"	7' 9"

33

■ **Lens (with Seiko #1 Shutter)**

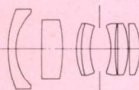

**90<sup>mm</sup> f/3.8**

Composition : 7 elements in 6 groups  
 Picture angle : 51° 50'  
 Minimum aperture : 32  
 Filter diameter : 77 mm  
 Hood : Screw-in type  
 Weight : 24.7/8 oz (705 g)

**Depth of Field Table**

Aperture	Distance in Meter									
	∞	10	5	3	2	1.5	1	0.8	0.6	0.5
3.8	24.57	7.17	4.20	2.70	1.87	1.43	0.973	0.784	0.593	0.496
	∞	16.60	6.19	3.37	2.15	1.58	1.029	0.816	0.607	0.504
5.6	16.54	6.31	3.90	2.58	1.82	1.40	0.960	0.777	0.590	0.494
	∞	24.59	7.01	3.59	2.23	1.62	1.044	0.825	0.611	0.506
8	11.73	5.48	3.57	2.44	1.75	1.36	0.945	0.768	0.586	0.492
	∞	63.09	8.43	3.91	2.34	1.67	1.064	0.835	0.615	0.508
11	8.33	4.62	3.20	2.27	1.66	1.31	0.924	0.756	0.580	0.489
	∞	∞	11.84	4.48	2.52	1.76	1.093	0.851	0.622	0.512
16	5.92	3.79	2.79	2.06	1.56	1.25	0.896	0.739	0.572	0.485
	∞	∞	28.05	5.67	2.84	1.89	1.138	0.875	0.632	0.517
22	4.22	3.04	2.37	1.83	1.43	1.17	0.860	0.717	0.561	0.479
	∞	∞	∞	9.12	3.45	2.13	1.208	0.911	0.646	0.524
32	3.02	2.38	1.96	1.59	1.28	1.08	0.814	0.688	0.547	0.470
	∞	∞	∞	∞	5.03	2.60	1.327	0.968	0.668	0.536

**Depth of Field Table**

Aperture	Distance in Feet									
	∞	30	15	10	7	5	4	3	2	1.5
3.8	80' 7"	22' 1"	12' 9"	9'	6' 6"	4' 9 3/4"	3' 10 3/4"	2' 11"	1' 11 3/4"	1' 5 3/8"
	∞	47' 1"	18' 2"	11' 3"	7' 7"	5' 3"	4' 1 3/4"	3' 3/4"	2' 3/4"	1' 6 3/8"
5.6	54' 3"	19' 7"	11' 11"	8' 7"	6' 3 1/2"	4' 8"	3' 9 1/2"	2' 10 3/4"	1' 11 3/4"	1' 5 3/8"
	∞	65' 4"	20' 3"	12"	7' 10 1/2"	5' 5"	4' 2 3/4"	3' 1 1/4"	2' 3/2"	1' 6 3/8"
8	38' 6"	17' 1"	11"	8' 1 1/2"	6' 1/2"	4' 6 1/4"	3' 8 1/4"	2' 10 1/4"	1' 11 3/4"	1' 5 3/8"
	∞	129"	23' 10"	13' 1"	8' 3 3/4"	5' 7"	4' 4"	3' 2"	2' 3/8"	1' 6 3/8"
11	27' 4"	14' 7"	9' 11"	7' 6 1/2"	5' 9"	4' 4 1/4"	3' 7 1/4"	2' 9 3/4"	1' 11 3/4"	1' 5 3/8"
	∞	∞	31' 7"	15' 1"	9"	5' 10 1/2"	4' 6"	3' 3"	2' 3/8"	1' 6 3/8"
16	19' 5"	12"	8' 8 1/2"	6' 10"	5' 4"	4' 1 1/4"	3' 5 1/4"	2' 8 3/4"	1' 10 3/4"	1' 5 3/8"
	∞	∞	59' 2"	19' 2"	10' 3"	6' 4"	4' 9"	3' 4 1/4"	2' 1 3/4"	1' 6 3/8"
22	13' 10"	9' 8 1/2"	7' 5 1/2"	6' 1/2"	4' 10 3/4"	3' 10 1/2"	3' 3 1/2"	2' 7 1/4"	1' 10 3/4"	1' 5 3/8"
	∞	∞	∞	31' 6"	12' 10"	7' 2"	5' 2"	3' 6 1/4"	2' 1 3/4"	1' 6 3/8"
32	9' 10 1/2"	7' 7 1/2"	6' 2 1/2"	5' 3"	4' 4 1/4"	3' 6 3/4"	3' 3/4"	2' 6"	1' 9 3/4"	1' 5 3/8"
	∞	∞	∞	∞	20"	8' 9 1/2"	5' 11"	3' 9 3/4"	2' 2 3/4"	1' 7"

34

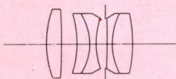

**127<sup>mm</sup> f/3.8**

Composition : 5 elements in 3 groups  
 Picture angle : 38° 16'  
 Minimum aperture : 32  
 Filter diameter : 77 mm  
 Hood : Screw-in type  
 Weight : 23-1/8 oz (655 g)

**Depth of Field Table**

Aperture	Distance in Meter									
	∞	10	5	3	2	1.5	1	0.8	0.7	0.65
3.8	47.96	8.33	4.56	2.84	1.93	1.47	0.987	0.793	0.695	0.646
	∞	12.53	5.54	3.17	2.07	1.54	1.01	0.807	0.704	0.654
4	45.57	8.26	4.54	2.84	1.93	1.46	0.986	0.793	0.695	0.646
	∞	12.70	5.57	3.18	2.07	1.54	1.01	0.807	0.705	0.654
5.6	32.26	7.70	4.37	2.77	1.90	1.45	0.981	0.790	0.693	0.645
	∞	14.30	5.84	3.27	2.11	1.55	1.02	0.811	0.707	0.655
8	22.84	7.03	4.16	2.69	1.87	1.43	0.973	0.786	0.690	0.643
	∞	17.42	6.29	3.39	2.16	1.58	1.03	0.815	0.710	0.658
11	16.19	6.27	3.89	2.58	1.82	1.40	0.963	0.780	0.687	0.640
	∞	25.24	7.04	3.59	2.23	1.61	1.04	0.822	0.714	0.661
16	11.48	5.44	3.56	2.44	1.75	1.37	0.948	0.772	0.681	0.635
	∞	69.73	8.50	3.91	2.34	1.67	1.06	0.831	0.720	0.666
22	8.16	4.59	3.19	2.27	1.67	1.32	0.929	0.761	0.674	0.630
	∞	∞	12.04	4.49	2.52	1.75	1.09	0.845	0.729	0.672
32	5.80	3.76	2.78	2.06	1.56	1.26	0.903	0.746	0.664	0.622
	∞	∞	29.80	5.69	2.83	1.88	1.126	0.865	0.742	0.682

**Depth of Field Table**

Aperture	Distance in Feet									
	∞	30	15	10	7	5	4	3	2.5	2.25
3.8	157'	25' 4"	13' 9"	9' 5 1/2"	6' 9"	4' 10 1/2"	3' 11 1/4"	3' 0"	2' 5 3/4"	2' 2 3/8"
	∞	36' 9"	16' 5"	10' 0"	7' 3"	5' 1 1/2"	4' 3/4"	3' 3/4"	2' 6 3/4"	2' 3 3/8"
4	149'	25' 2"	13' 8"	9' 5"	6' 9"	4' 10 1/2"	3' 11"	2' 11 1/2"	2' 5 3/4"	2' 2 3/8"
	∞	37' 2"	16' 6"	10' 7"	7' 3 1/2"	5' 1 1/2"	4' 1"	3' 3/2"	2' 6 3/4"	2' 3 3/8"
5.6	106'	23' 7"	13' 3"	9' 8"	6' 7 1/2"	4' 10"	3' 10 3/4"	2' 11 1/2"	2' 5 1/2"	2' 2 3/8"
	∞	41' 4"	17' 3"	10' 11"	7' 5"	5' 2"	4' 1 1/4"	3' 3 1/4"	2' 6 1/4"	2' 3 3/8"
8	74' 11"	21' 8"	12' 8"	8' 11 1/2"	6' 6"	4' 9"	3' 10 1/4"	2' 11"	2' 5 1/2"	2' 2 3/8"
	∞	49' 0"	18' 5"	11' 4"	7' 7"	5' 3"	4' 1 3/4"	3' 1"	2' 6 1/4"	2' 3 3/8"
11	53' 1"	19' 5"	11' 11"	8' 7"	6' 3 1/2"	4' 8"	3' 9 3/4"	2' 11"	2' 5 1/4"	2' 2 3/8"
	∞	66' 8"	20' 4"	12' 0"	7' 10 1/2"	5' 4 1/2"	4' 2 3/4"	3' 1 1/4"	2' 6 3/4"	2' 3 3/8"
16	37' 8"	17' 0"	11' 0"	8' 1"	6' 1"	4' 6 1/4"	3' 8 3/4"	2' 10 1/2"	2' 5"	2' 2 3/8"
	∞	137'	23' 11"	13' 1"	8' 3 1/2"	5' 7"	4' 4"	3' 1 3/4"	2' 7"	2' 3 3/8"
22	26' 9"	14' 5"	9' 10"	7' 6"	5' 9"	4' 4 1/4"	3' 7 1/2"	2' 9 3/4"	2' 4 3/8"	2' 2"
	∞	∞	31' 11"	15' 1"	9' 0"	5' 10"	4' 5 3/4"	3' 2 3/4"	2' 7 1/4"	2' 4 3/8"
32	19' 0"	11' 11"	8' 7 1/2"	6' 10"	5' 4 1/2"	4' 2"	3' 6"	2' 9"	2' 4 1/4"	2' 1 3/8"
	∞	∞	61' 3"	19' 3"	10' 2"	6' 3 3/4"	4' 8 1/2"	3' 3 3/4"	2' 8 1/4"	2' 4 1/8"

**■ Lens (with Seiko # 1 Shutter)**

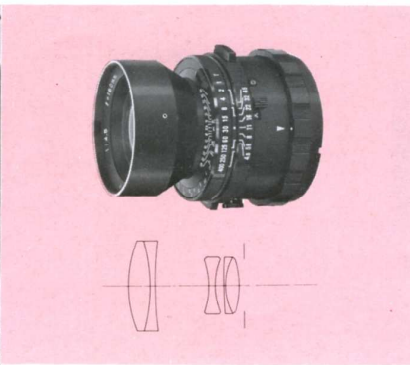

# 180<sup>mm</sup> f/4.5

Composition : 5 elements in 3 groups  
 Picture angle : 28°  
 Minimum aperture : 45  
 Filter diameter : 77mm  
 Hood : Screw-in type  
 Weight : 30-14/16 oz (875 g)

**Depth of Field Table**

Aperture	Distance in Meter									
	∞	30	15	10	7	5	3	2	1.5	1.2
4.5	80.18 ∞	21.94 47.55	12.71 18.32	8.94 11.34	6.48 7.62	4.74 5.30	2.91 3.10	1.96 2.04	1.48 1.52	1.19 1.21
5.6	63.82 ∞	20.53 55.99	12.23 19.43	8.71 11.75	6.36 7.79	4.67 5.38	2.89 3.12	1.96 2.05	1.48 1.52	1.19 1.21
8	45.18 ∞	18.16 87.53	11.36 22.14	8.27 12.68	6.12 8.18	4.55 5.55	2.85 3.17	1.94 2.07	1.47 1.53	1.18 1.22
11	32.00 ∞	15.62 ∞	10.33 27.62	7.72 14.26	5.82 8.80	4.39 5.82	2.79 3.25	1.91 2.10	1.46 1.55	1.18 1.23
16	22.68 ∞	13.05 ∞	9.16 42.59	7.06 17.35	5.45 9.85	4.18 6.25	2.71 3.37	1.88 2.14	1.44 1.57	1.17 1.24
22	16.09 ∞	10.60 ∞	7.90 ∞	6.30 25.08	4.99 11.88	3.91 6.98	2.60 3.56	1.83 2.20	1.42 1.60	1.15 1.25
32	11.43 ∞	8.39 ∞	6.62 ∞	5.47 68.63	4.47 16.80	3.60 8.37	2.47 3.86	1.77 2.30	1.38 1.64	1.14 1.27
45	8.13 ∞	6.49 ∞	5.40 ∞	4.62 ∞	3.90 41.26	3.23 11.71	2.30 4.38	1.70 2.46	1.34 1.71	1.11 1.31

**Depth of Field Table**

Aperture	Distance in Feet									
	∞	100	50	30	20	15	10	7	5	4
4.5	263' 0" ∞	72' 10" 160' 0"	42' 3" 61' 3"	27' 1" 33' 7"	18' 8" 21' 6"	14' 3" 15' 10"	9' 8 1/2" 10' 4"	6' 10 1/2" 7' 1 1/2"	4' 11 1/4" 5' 1 1/2"	3' 11 1/4" 4' 1 1/2"
5.6	209' 0" ∞	68' 1" 189' 0"	40' 8" 65' 1"	26' 5" 34' 8"	18' 5" 21' 11"	14' 1" 16' 0"	9' 7 1/2" 10' 5"	6' 10" 7' 2"	4' 11" 5' 1"	3' 11 1/4" 4' 1 1/2"
8	148' 0" ∞	60' 2" 301' 0"	37' 9" 74' 5"	25' 2" 37' 2"	17' 10" 22' 10"	13' 9" 16' 6"	9' 5 1/2" 10' 7"	6' 9" 7' 3"	4' 10 1/4" 5' 1 1/2"	3' 11 1/4" 4' 1 1/2"
11	105' 0" ∞	51' 8" ∞	34' 3" 93' 5"	23' 8" 41' 2"	17' 0" 24' 3"	13' 4" 17' 2"	9' 3 1/2" 10' 10"	6' 8" 7' 4 1/2"	4' 10 1/4" 5' 2"	3' 11" 4' 1"
16	74' 5" ∞	43' 1" ∞	30' 4" 146' 0"	21' 9" 48' 10"	16' 1" 26' 8"	12' 9" 18' 4"	9' 0" 11' 3"	6' 6 1/2" 7' 6 1/2"	4' 9 1/2" 5' 3"	3' 10 1/4" 4' 1 1/2"
22	52' 9" ∞	34' 11" ∞	26' 2" ∞	19' 7" 66' 2"	14' 10" 30' 11"	12' 0" 20' 2"	8' 8" 11' 11"	6' 4 1/2" 7' 9 1/2"	4' 8 1/2" 5' 4"	3' 10" 4' 2 1/4"
32	37' 6" ∞	27' 8" ∞	21' 10" ∞	17' 1" 135' 0"	13' 5" 23' 7"	11' 1" 13' 11"	8' 2 1/2" 12' 11"	6' 1 1/2" 8' 2"	4' 7 1/4" 5' 6"	3' 9 1/4" 4' 3"
45	26' 8" ∞	21' 4" ∞	17' 10" ∞	14' 7" ∞	11' 11" 69' 11"	10' 0" 31' 1"	7' 7 1/2" 14' 9"	5' 10" 8' 9 1/2"	4' 5 1/2" 5' 8 1/2"	3' 8 1/4" 4' 4 1/2"

36

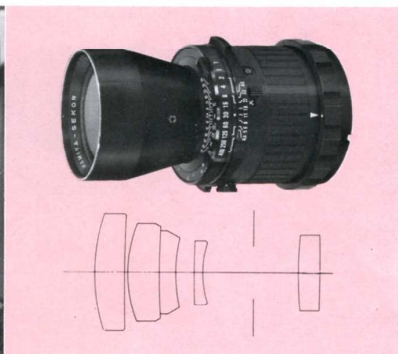

# 250<sup>mm</sup> f/4.5

Composition : 5 elements in 4 groups  
 Picture angle : 20°  
 Minimum aperture : 45  
 Filter diameter : 77 mm  
 Hood : Screw-in type  
 Weight : 46-3/16 oz (1310 g)

**Depth of Field Table**

Aperture	Distance in Meter									
	∞	50	30	20	15	10	7	5	3	2
4.5	155 ∞	37.9 73.5	25.2 37.0	17.8 22.9	13.7 16.5	9.44 10.6	6.73 7.30	4.87 5.14	2.96 3.04	1.98 2.02
5.6	123 ∞	35.7 83.6	24.2 39.4	17.3 23.7	13.4 17.0	9.30 10.8	6.66 7.38	4.83 5.18	2.95 3.06	1.98 2.02
8	87.1 ∞	32.0 116	22.5 45.3	16.4 25.7	12.9 18.0	9.04 11.2	6.53 7.54	4.77 5.26	2.92 3.08	1.97 2.03
11	61.6 ∞	27.8 57.5	20.3 57.5	15.2 29.2	12.2 19.6	8.69 11.8	6.36 7.80	4.68 5.37	2.89 3.11	1.96 2.04
16	43.7 ∞	23.5 ∞	18.0 93.1	13.9 36.1	11.3 22.4	8.25 12.7	6.12 8.19	4.56 5.55	2.85 3.16	1.94 2.06
22	30.9 ∞	19.3 ∞	15.4 ∞	12.3 54.4	10.3 28.2	7.70 14.4	5.82 8.81	4.40 5.81	2.80 3.24	1.92 2.09
32	22.0 ∞	15.4 ∞	12.9 ∞	10.7 195	9.09 44.7	7.03 17.6	5.45 9.88	4.19 6.23	2.72 3.75	1.89 2.12
45	15.6 ∞	12.0 ∞	10.4 ∞	8.95 ∞	7.84 ∞	6.28 25.8	5.00 11.9	3.93 6.96	2.62 3.52	1.85 2.18

**Depth of Field Table**

Aperture	Distance in Feet								
	∞	200	100	50	30	20	15	10	7
4.5	507 ∞	144 328	83' 10" 124'	45' 9" 55' 2"	28' 5" 31' 9"	19' 4" 20' 9"	14' 8" 15' 5"	9' 10" 10' 2"	6' 11 1/2" 7' 1"
5.6	404 ∞	134 393	80' 6" 132'	44' 9" 56' 8"	28' 1" 32' 2"	19' 2" 20' 11"	14' 7" 15' 6"	9' 10" 10' 2"	6' 11" 7' 1"
8	286 ∞	118 657	74' 7" 152'	42' 10" 60' 1"	27' 4" 33' 3"	18' 10" 21' 4"	14' 4" 15' 8"	9' 9" 10' 3"	6' 10 1/2" 7' 1 1/2"
11	202 ∞	101 ∞	67' 5" 195'	40' 6" 65' 6"	26' 5" 34' 9"	18' 5" 21' 11"	14' 1" 16' 0"	9' 7 1/2" 10' 5"	6' 10" 7' 2"
16	143 ∞	84' 1" ∞	59' 6" 321'	37' 6" 75' 3"	25' 2" 37' 3"	17' 10" 22' 10"	13' 10" 16' 5"	9' 6" 10' 7"	6' 9 1/2" 7' 3"
22	102 ∞	67' 11" ∞	51' ∞	34' 1" 95' 5"	23' 7" 41' 5"	17' 1" 24' 3"	13' 4" 17' 2"	9' 3 1/2" 10' 10"	6' 8 1/2" 7' 4"
32	72 ∞	53' 5" ∞	42' 6" ∞	30' 1" 154'	21' 8" 49' 3"	16' 1" 26' 8"	12' 9" 18' 3"	9' 1/2" 11' 2"	6' 7" 7' 6"
45	51' 2" ∞	41' 2" ∞	34' 5" ∞	25' 11" ∞	19' 6" 67' 6"	14' 11" 30' 11"	12' 1" 20' 1"	8' 8 1/2" 11' 9"	6' 5" 7' 8 1/2"

37

**Lens (with Seiko #1 Shutter)**

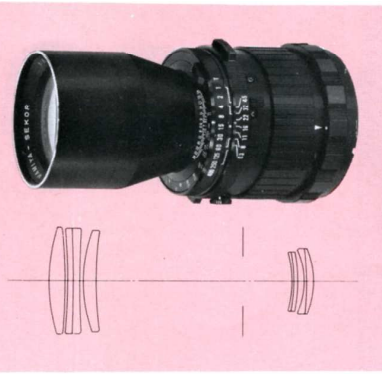

**360<sup>mm</sup> f/6.3**

Composition : 8 elements in 5 groups  
 Picture angle : 14°  
 Minimum aperture : 45  
 Filter diameter : 77mm  
 Hood : Screw-in type  
 Weight : 43 - 6/16 oz (1230 g)

**Depth of Field Table**

Aperture	Distance in Meter									
	∞	100	50	30	20	15	10	7	5	4
6.3	228.93	69.83	41.20	26.64	18.47	14.14	9.62	6.82	4.92	3.95
	∞	176.51	63.64	34.35	21.81	15.97	10.41	7.19	5.09	4.05
8	180.36	64.58	39.33	25.85	18.10	13.93	9.53	6.78	4.89	3.94
	∞	222.55	68.71	35.76	22.35	16.26	10.52	7.24	5.11	4.07
11	127.64	56.34	36.15	24.46	17.42	13.52	9.35	6.69	4.85	3.91
	∞	453.28	81.36	38.85	23.50	16.85	10.76	7.34	5.16	4.09
16	90.36	47.74	32.44	22.73	16.54	13.00	9.10	6.57	4.79	3.87
	∞	∞	110.06	44.29	25.35	17.76	11.10	7.49	5.23	4.13
22	64.00	39.28	28.34	20.66	15.44	12.32	8.78	6.41	4.71	3.83
	∞	∞	220.31	55.25	28.53	19.23	11.64	7.72	5.33	4.19
32	45.36	31.44	24.06	18.32	14.11	11.48	8.36	6.19	4.60	3.76
	∞	∞	∞	85.18	34.71	21.80	12.50	8.07	5.48	4.28
45	32.18	24.55	19.84	15.80	12.59	10.47	7.83	5.91	4.46	3.67
	∞	∞	∞	∞	50.16	26.90	13.95	8.62	5.71	4.41

**Depth of Field Table**

Aperture	Distance in Feet									
	∞	700	500	200	100	70	50	30	20	15
6.3	751'	363'	301'	159'	88' 7"	64' 4"	47' 1"	29'	19' 7"	14' 9"
	∞	∞	1484'	271'	115'	76' 10"	53' 4"	31' 1"	20' 5"	15' 3"
8	592'	322'	272'	150'	86'	62' 11"	46' 4"	28' 9"	19' 6"	14' 9"
	∞	∞	3172'	300'	120'	78' 11"	54' 3"	31' 5"	20' 7"	15' 4"
11	419'	263'	229'	136'	81' 3"	60' 5"	45'	28' 3"	19' 3"	14' 7"
	∞	∞	∞	379'	130'	83' 4"	56' 3"	32'	20' 10"	15' 5"
16	296'	209'	187'	120'	75' 5"	57' 2"	43' 3"	27' 7"	18' 11"	14' 5"
	∞	∞	∞	602'	149'	90' 5"	59' 5"	33'	21' 2"	15' 7"
22	210'	162'	149'	103'	68' 6"	53' 2"	40' 11"	26' 8"	18' 7"	14' 3"
	∞	∞	∞	∞	187'	103'	64' 5"	34' 5"	21' 9"	15' 10"
32	149'	123'	115'	86' 2"	60' 8"	48' 5"	38' 1"	25' 6"	18'	13' 11"
	∞	∞	∞	∞	293'	128'	73' 3"	36' 7"	22' 6"	16' 3"
45	106'	92'	87' 8"	69' 11"	52' 3"	42' 11"	34' 9"	24'	17' 4"	13' 6"
	∞	∞	∞	∞	∞	196'	90' 11"	40' 4"	23' 9"	16' 10"

38

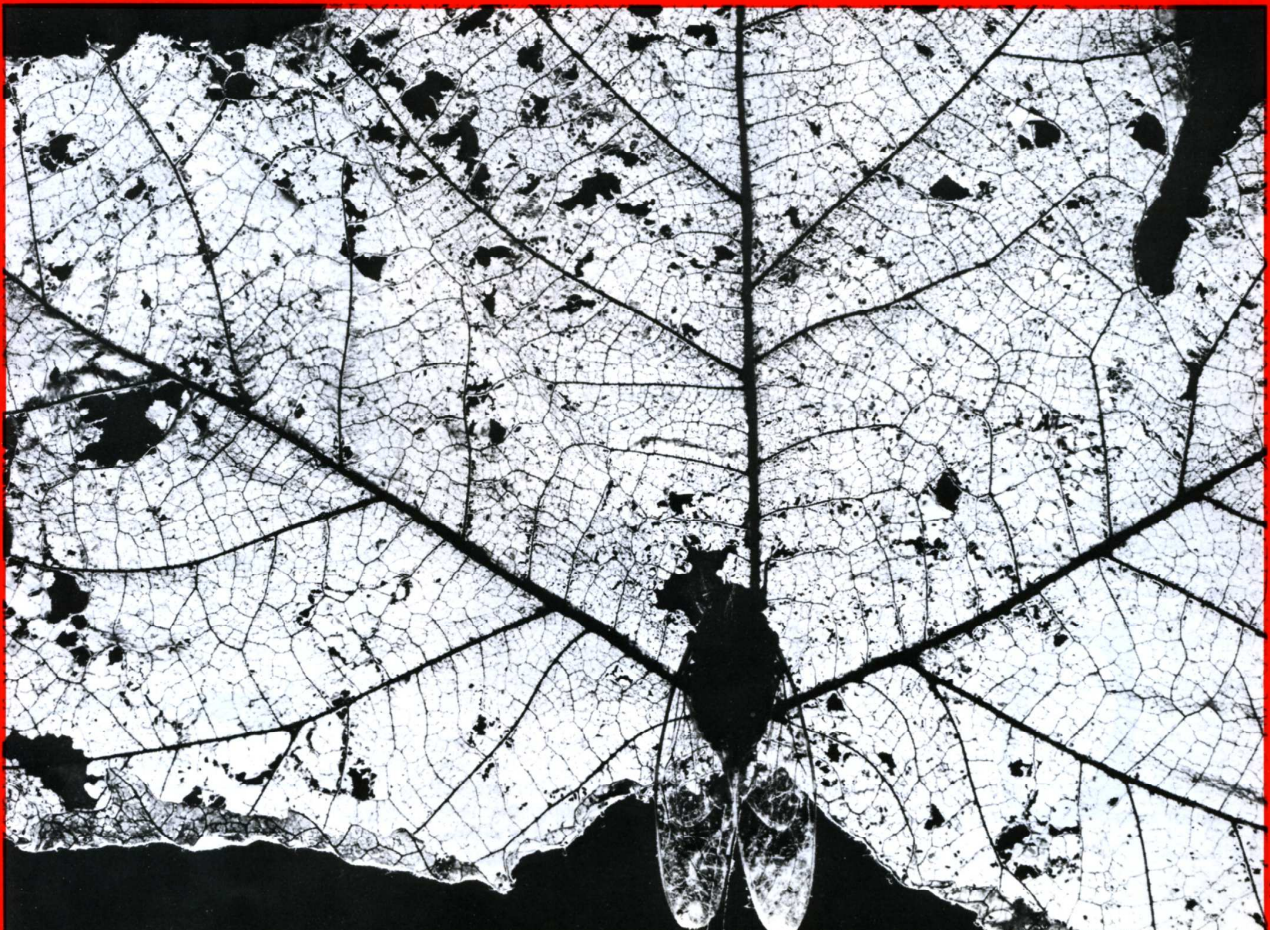

## ■ Accessories Exclusively for the Mamiya RB67

### Filters

Filters of 77mm diameter can be used for all lenses. Seven different filters are available — Y2 (Yellow 2), YG (Yellow Green), O2 (Orange 2), UV (Haze), SL (Skylight), PL (Polarizing), and ND16 (Neutral Density 16).

#### PL Filter (Polarizing Filter)

The PL filter eliminates light reflections from water and or glass surfaces, making subjects in water or displayed in show windows much clearer. It also eliminates unwanted reflections from nonmetallic surfaces, revealing surface detail. For outdoor photography the PL filter can be used to dramatically darken the blue sky.

### Gelatin Filter Holder

Gelatin filters allow selection of a wide variety of colors and ensure high optical quality. The Mamiya gelatin filter holder is designed to mount a 3 inch (7.5cm) square gelatin filter to the camera lens.



### Lens Hoods



50mm f/4.5 lens	Common use	Slip-on type 80mm $\phi$
65mm f/4.5 lens		
90mm f/3.8 lens	Common use	Screw-in type 77mm $\phi$
127mm f/3.8 lens		
180mm f/4.5 lens		
250mm f/4.5 lens		
360mm f/6.3 lens	Exclusive use	

### Auto Extension Tubes



There are two types of auto extension tubes available (No. 1 and No. 2) both of which couple to the automatic aperture of the lens. Both can be used at the same time when required.

Life-size close-ups can be obtained by combining an extension tube No. 1 and a 90 mm f/3.8 lens, or an extension tube No. 2 and a 127 mm f/3.8 lens.

### Sun Shield

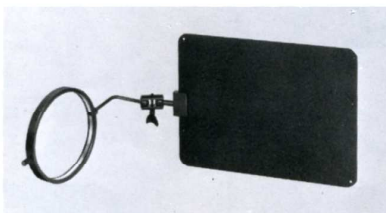

This is a shield, attaching to the lens when photographing against the sun, and can be rotated easily to prevent direct sunlight from striking the lens. You can take clear, crisp photos without disappointing flares or ghost images.

### Mirror-up Cable Release

This forked (Y-shape) cable release is indispensable in fully utilizing the mirror-up (independent mirror release) mechanism of the Mamiya RB67.



40

### Focusing Screen

Five different types of focusing screens are available to meet individual needs or preference.

Description	Specification	Application
<p>No. 1 Matte</p>	Entirely matted with Fresnel lens	For general photography.
<p>No. 2 Checker</p>	Entirely matted with Fresnel lens and sectional grid markings	Grid markings are added to the No. 1 Matte. Convenient in arranging composition. Most suitable for close-ups, copying, and photographing buildings.
<p>No. 3 Rangefinder spot</p>	Entirely matted with Fresnel lens and split prism at center	For general photography. Convenient for quick, accurate focusing with the central split prism. Focusing can also be done in the surrounding matte area.
<p>No. 4 Microprism</p>	Entirely matted with Fresnel lens and microprism at center	For general photography. Convenient for quick focusing with the central microprism. Focusing can also be done in the surrounding matte area.
<p>No. 5 Cross-hair</p>	Entirely matted Center small circular portion is transparent with cross hairs marker	For special photography. Suitable for high magnification close-up or telephoto photography, using parallax focusing.

## ■ Accessories Exclusively for the Mamiya RB 67



### Magnifying hood

By attaching a magnifying hood in place of the focusing hood, the ground glass focusing screen will be further shielded from extraneous light, offering easy viewing of the image either outdoors or in the studio. The magnifier has 2.5X magnification.



### Universal sportsfinder

Since it provides a wide range of view even outside the viewfinder field, this is very convenient for photographing quickly moving objects such as sports events, air meets, races, etc. You can focus on the focusing screen with the sportsfinder attached to the camera.



### CdS finder

This is a magnifying hood with a built-in CdS exposure meter. Since the meter measures light which passes through the lens, the correct exposure setting is easily obtained. A compensating exposure factor need not be considered even if the bellows are extended and/or extension tubes or filters are used.



### Grip Holder for Mamiya RB and C330

This grip holder is a very convenient accessory for hand-holding the camera or for carrying it. An accessory shoe is attached. The camera shutter can be released by triggering the shutter button of this grip. This grip can also be used for the Mamiya C330.



### Prism Finder

Through this prism finder, the image on the ground glass focusing screen appears exactly as the subject is seen. Really an indispensable accessory for eye-level photos, press photography, or candid shots.

Viewing angle : 30°  
Finder magnification : 2.2X



### Focusing knob adapter

This adapter eases rapid accurate focusing. It attaches quite simply to the focusing knob.

42

## ■ G-lock System Accessories



### 120 Roll Film Holder

10 exposures on 6×7 cm format  
Film used: 120 roll film  
Film advance: Advance lever in one stroke  
(Can also be wound in several short, definite strokes)

Exposure counter: Automatic resetting  
With double-exposure warning device

### 220 Roll Film Holder

20 exposures on 6×7 cm format  
Film used: 220 roll film  
Other specifications are the same as 120 roll film holder.

### 120 Roll Film Holder 6×4.5

16 exposures on 6×4.5 cm format  
Film used: 120 roll film  
Finder mask for 6×4.5 format comes with the holder  
Other specifications are the same as the 120 roll film holder



### Double Cut Film/Plate Holder

There are two types of double cut film/plate holders; type A and type J.  
**Cut film used:**  
2-1/2×3-1/2 inch, (6.5×9 cm); two exposures; can be used for the both types of holders.

**Dry plate used:**  
2-1/2×3-1/2 inch, (6.5×9 cm); two exposures; can be used for the both types of holders.

**When type A holder and its sheath are used:**  
Two exposures with 2-1/4×3-1/4 inch cut films.

**When type J holder and its sheath are used.**

Two exposures with one-quarter of 4-3/4×6-1/2 inch, (12×16.5 cm) cut film.

In either case, the picture size will be a 6×7 cm format. However, when film sheath type A is used, it will be little smaller than 6×7 cm format in width.



### Film Pack Adapter

Film pack used: 2-1/4×3-1/4 inch or 2-1/2×3-1/2 inch, 6.5×9 cm  
The actual picture size will be a 6×7 cm format.



### Plate Holder Adapter

When this adapter is attached to the back of the camera, the plate holder model 2 for Mamiya C can be used.

43

## ■ Lock System of the Camera Back

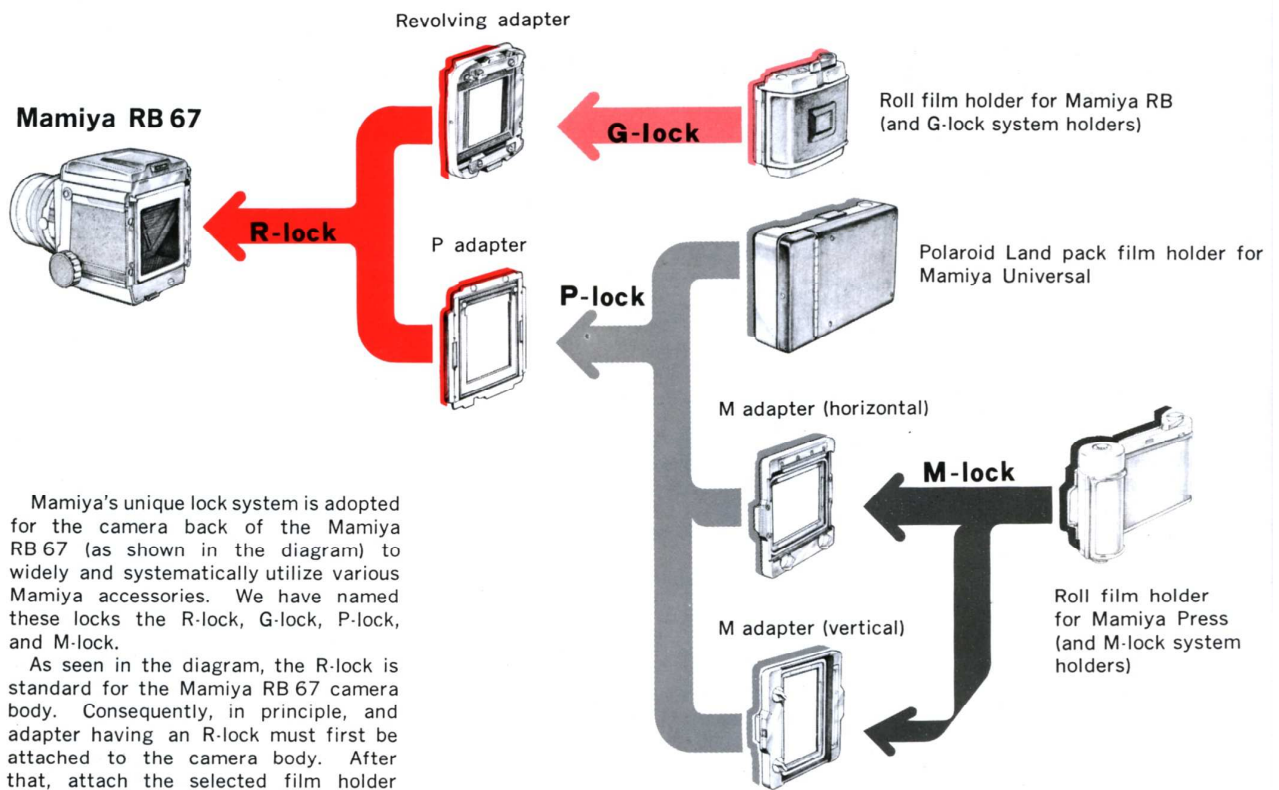

Mamiya's unique lock system is adopted for the camera back of the Mamiya RB 67 (as shown in the diagram) to widely and systematically utilize various Mamiya accessories. We have named these locks the R-lock, G-lock, P-lock, and M-lock.

As seen in the diagram, the R-lock is standard for the Mamiya RB 67 camera body. Consequently, in principle, an adapter having an R-lock must first be attached to the camera body. After that, attach the selected film holder through the adapter indicated on the diagram.

44

## ■ Adapter for Using Mamiya Accessories

**P Adapter**



By attaching this adapter on the camera back, the following adapters and holders can be used:

- M adapter (Horizontal)
- M adapter (Vertical)
- Polaroid Land pack film holder for Mamiya Universal camera

**M Adapter (Horizontal)**

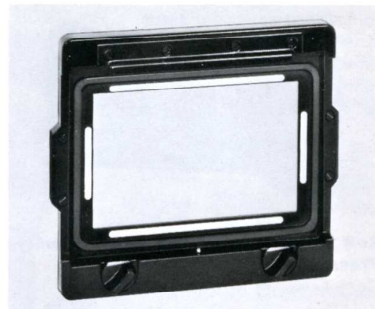

**M Adapter (Horizontal) and M Adapter (Vertical)**

Adding the M adapter to the P adapter permits the use of the following Mamiya Press accessories:

- Roll film holder for the Mamiya Press
- Roll film holder model K for the Mamiya Press
- Focusing screen holder for the Mamiya Press

The M adapter (Horizontal), the same as the M adapter for the Mamiya Universal camera, is used for photography in the horizontal format. The M adapter (vertical) is used for the vertical format.

**M Adapter (Vertical)**





## ■ General Accessories

Various accessories for Mamiya Press Series cameras can be used with the RB 67.

### P-lock System

Polaroid Land pack film holder for Mamiya Universal camera

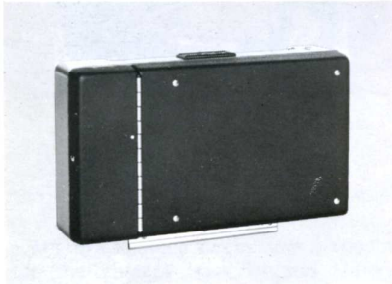

Film used :  
Polaroid 8-exposure, 3-1/4 x 4-1/4 inch Land film pack.  
For color picture; Polaroid Polacolor® film, type 108.  
For black-and-white picture; Polaroid 3000 speed film, type 107.

### M-lock System

Roll film holder for Mamiya Press



Roll film holder model K for Mamiya Press



Focusing screen holder for Mamiya Press



Cut film/plate holder type J for Mamiya Press

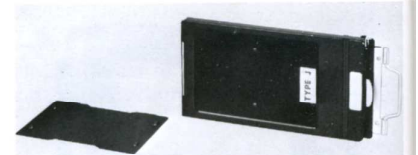

Cut film/plate holder type A for Mamiya Press

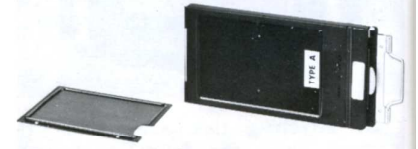

Film pack adapter for Mamiya Press



Quick shoe

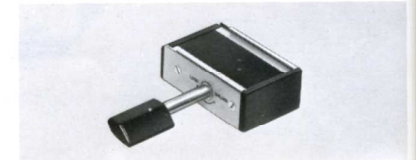

46

### Flashgun

Highly efficient, large BC type flashgun—usable with both a screw-base bulb and a bayonet type base bulb—supplies sufficient light for taking pictures under any condition.

### Flashgun Adapter

This adapter allows use of the Mamiya flashgun with an accessory shoe to accommodate a clip-on type flash unit.



### Compartment Case

This compartment case accommodates the camera with the 90mm lens and roll film holder as well as housing the 65mm and 127mm lenses. Also the case can hold the camera with the 250mm lens and a roll film holder.

Inner dimensions :  
Length: 1 1" (33cm)  
Width: 7 1/2" (19cm)  
Depth: 6 3/4" (17cm)  
Height of top cover: 2 1/2" (5.5cm)



### Aluminum Custom Case

The Mamiya Custom Case is a smartly portable, luggage-type aluminum case.

The Custom Case is designed to accommodate and to easily hand-carry normally required interchangeable lenses and accessories as well as standard equipment. By changing the inserts, the Custom Case conveniently accommodates the Mamiya RB, Mamiya C, or Mamiya Press and related equipment.

The interchangeable inserts, made of sponge rubber, provide effective shock absorption and sufficient protection of the equipment.

The case measures 18 3/4" x 13 3/4" x 6 3/4" (47 x 35 x 17cm) and weighs 8 lbs, 2 1/2 oz., (3.7kg).



### Soft leather case

This is a flexible, soft leather case convenient for lens protection and carrying. It can also be used as a case for the auto extension tube or the Mamiya Press lenses (50mm to 150mm focal lengths).



47

# Mamiya RB 67 System Chart



Due to a modification of the product, design and specifications are subject to change without notice.

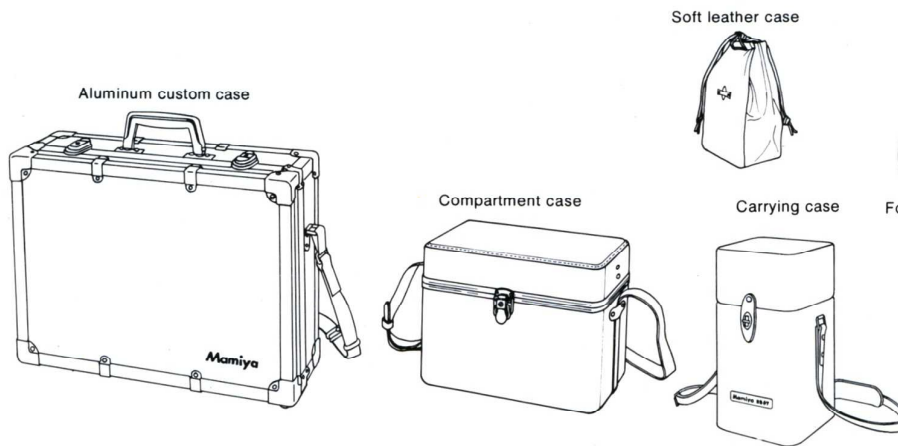
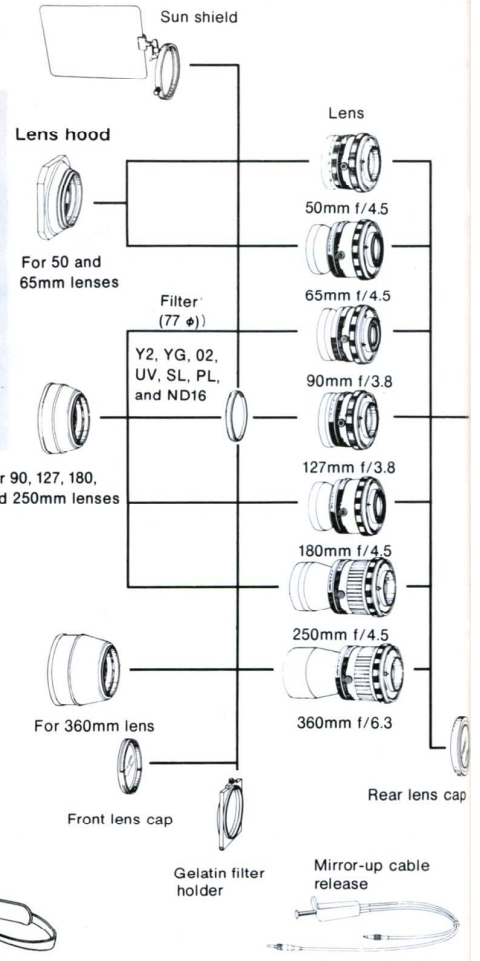

48

"Polaroid" and "Polacolor" are registered trademarks of Polaroid Corporation, Cambridge, Mass. U.S.A.  
"Graflex" and "Graflex" are registered trademarks of the Singer Company/Graflex Division, Rochester N.Y. U.S.A.

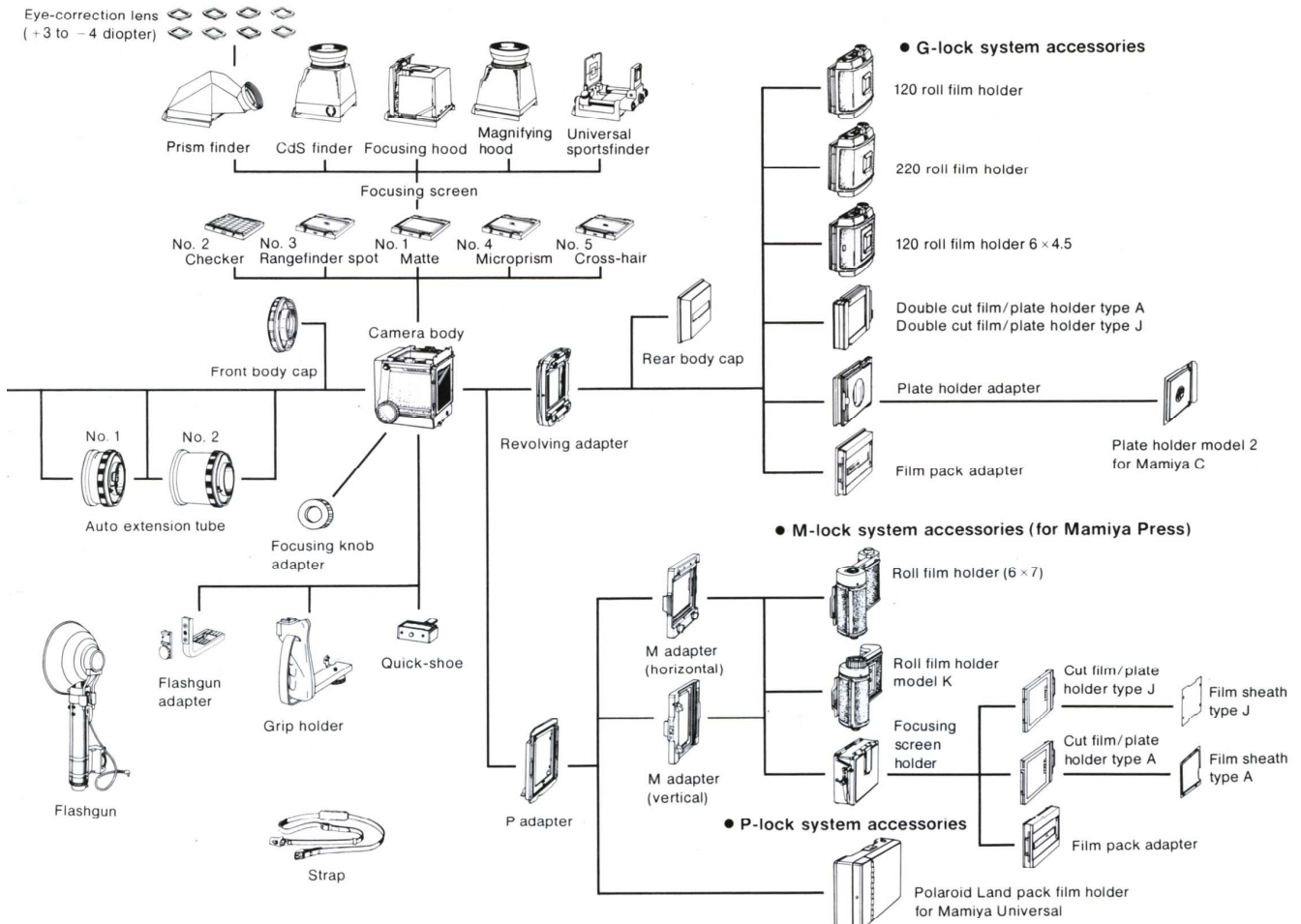



Shin Meikei Bldg. 3-1, Otsuka 3-Chome, Bunkyo-Ku, Tokyo, Japan